

Dell™ Remote Console
Switch
User's Guide



Notes, Cautions, and Warnings



NOTE: A NOTE indicates important information that helps you make better use of your computer.



CAUTION: A CAUTION indicates potential damage to hardware or loss of data if instructions are not followed.



WARNING: A WARNING indicates a potential for property damage, personal injury, or death.

Information in this document is subject to change without notice.

© 2012 Dell Inc. All rights reserved.

Reproduction of these materials in any manner whatsoever without the written permission of Dell Inc. is strictly forbidden.

Trademarks used in this text: *Dell*, the *DELL* logo, and *PowerEdge* are trademarks of Dell Inc.; *Avocent* is a trademark or registered trademark of Avocent Corporation or its affiliates in the U.S. and other countries.

Other trademarks and trade names may be used in this document to refer to either the entities claiming the marks and names or their products. Dell Inc. disclaims any proprietary interest in trademarks and trade names other than its own.

590-1021-501B

July 2012

Model 1082DS/2162DS/4322DS Remote Console Switch

Contents

Product Overview	1
Features and Benefits	1
Reduce Cable Bulk	2
KVM Switching Capabilities	2
Multiplatform Support	2
True Serial Capabilities	3
Local and Remote User Interfaces	3
Virtual Media and Smart Card-capable Switches	3
On-board Web Interface	4
Access the Switch Using a Standard TCP/IP Network	4
Encryption	4
Video	4
Flash Upgradeable	5
Tier Expansion	5
Avocent Management Software Plug-in	5
FIPS cryptographic module	5
Sample Configuration	7
Safety Precautions	8
General	9
LAN Options	10
Installation	13
RCS Quick Setup	13
Getting Started	15
Setting up Your Network	16
Rack Mounting the RCS	16
Rack Mounting Safety Considerations	16
Installing the Dell ReadyRails™ System	17

Installing the RCS	22
Connecting the RCS Hardware	25
Connecting a SIP	29
Adding a Tiered Switch	31
Cascading with Legacy Switches	34
Adding a PEM (Optional)	36
Configuring the Remote Console Switch	38
Setting up the Built-in Web Server	38
Connecting to the OBWI Through a Firewall	38
Verifying the Connections	41
Rear Panel Ethernet Connection LEDs	41
Rear Panel Power Status LEDs	41
Adjusting Mouse Settings on Target Devices	42
Local and Remote Configuration	43
Local User Interface (UI)	43
Filtering	44
OBWI	45
Using the User Interfaces	47
Launching a Session	49
Scan Mode	50
Viewing System Information	51
RCS Tools	52
Rebooting the RCS	52
Upgrading RCS Firmware	52
Saving and Restoring RCS Configurations and RCS User Databases	53
Network Settings	55
DNS Settings	56

NTP Settings	57
SNMP Settings	57
Auditing Event Settings	58
Setting Event Destinations	58
Ports - Configuring SIPs	59
Upgrading SIPs	59
Power Device Settings	60
Associated Target Servers and Power Outlets	61
Grouping Power Outlets	63
Default Outlet Names	64
Assigning an Outlet Name	65
Local Session Page on the Local Port	69
Local Port UI Settings	70
Modem Settings	71
Setup Settings - Port Security	72
Sessions	72
Configuring General Sessions	72
Configuring KVM Sessions	73
Configuring Local Virtual Media Sessions	73
Configuring Serial Sessions	77
Setting Up User Accounts	77
Managing Local Accounts	77
Access Levels	77
Avocent Management Software Device IP Addresses	79
LDAP	79
Override Admin	79
Active Sessions	80
Closing a Session	80

The Video Viewer Window	81
Changing the Toolbar	83
Launching a Session	84
Session Time-out	84
Window Size	85
Adjusting the View	85
Refreshing the Image	87
Video Settings	87
Additional Video Adjustment	87
Target Video Settings	89
Automatic Video Adjustment	89
Video Test Pattern	90
Vendor-specific Video Settings	90
Color Settings	90
Adjusting Color Depth	90
Contrast and Brightness	91
Noise Settings	91
Detection Thresholds	91
Mouse Settings	92
Adjusting Mouse Options	92
Cursor Type	92
Mouse Scaling	95
Mouse Alignment and Synchronization	95
Virtual Media	96
Requirements	96
Sharing and Preemption Considerations	97
Virtual Media Dialog Box	97
Opening a Virtual Media Session	98
Closing a Virtual Media Session	101
Smart Cards	102

Keyboard Pass-through	103
Macros	104
Saving the View	104
Closing a Session	104
LDAP Feature for the RCS	105
The Structure of Active Directory	105
Domain Controller Computers	105
Object Classes	106
Attributes	107
Schema Extensions	107
Standard Schema versus Dell Extended Schema	108
Standard Installation	109
Configure the Override Admin Account	110
Configuring DNS Settings	110
Configuring the Network Time Protocol (NTP) Settings	112
Configuring the LDAP Authentication Parameters	112
Enabling LDAP Authentication	112
Entering Authentication Parameters - Operational Modes	115
Entering Extension Options - Active Directory LDAP	116
Entering Authentication Parameters - Standard LDAP	116
Entering Authentication Parameters - Custom IP Port Assignments	117
Completing LDAP Configuration	118
Secondary LDAP Settings - Standard Configuration	119
Setting up the RCS for performing Standard LDAP queries	119
Search Configuration Settings	120
Query Mode Selection Settings	121
Group Configuration Parameters	122
Secondary LDAP Settings - Active Directory Configuration	124

LDAP SSL Certificates	127
Enabling SSL on a Domain Controller	128
Login Timeout	132
CA Certificate Information Display	133
Configuring Group Objects	134
Active Directory Object Overview for Standard Schema	137
Dell Extended Schema Active Directory Object Overview	139
Configuring Active Directory with Dell Schema Extensions to Access Your RCS	143
Extending the Active Directory Schema (Optional)	143
Installing the Dell Extension to the Active Directory Users and Computers Snap-In (Optional)	144
Opening the Active Directory Users and Computers Snap- In	145
Adding Users and Privileges to Active Directory with Dell Schema Extensions	145
Creating a SIP Object	145
Creating a Privilege Object	146
Using Dell Association Objects Syntax	147
Creating an Association Object	148
Adding Objects to an Association Object	148
Console Redirection Access Security	149
Using Active Directory to Log In to the RCS	150
Target Device Naming Requirements for LDAP Implementation	151
Frequently Asked Questions	152
Appendix A: Terminal Operations	155
Console Boot Menu Options	155
Console Main Menu Options	156

Appendix B: Using SIPs	157
ACS Console Server Port Pinouts	157
Cisco Port Pinouts	158
Appendix C: MIB and SNMP Traps	159
Appendix D: Cable Pinouts Information	165
Modem Pinouts	165
Console/Setup Pinouts	166
Appendix E: UTP Cabling	167
UTP Copper Cabling	167
Wiring Standards	167
Cabling Installation, Maintenance, and Safety Tips	168
Appendix F: Sun Advanced Key Emulation	171
Appendix G: Technical Specifications	173
Appendix H: Technical Support	177

Product Overview

The Dell 1082DS/2162DS/4322DS Remote Console Switch (RCS) digital keyboard, video and mouse (KVM) over IP and serial console switches combine analog and digital technology to provide flexible, centralized control of data center servers, and to facilitate the operations, activation, and maintenance of remote branch offices where trained operators may be unavailable. The IP-based RCS gives you flexible target device management control and secure remote access from anywhere at anytime through the RCS software or on-board web interface (OBWI).

Features and Benefits

The RCS provides enterprise customers with the following features and options:

- significant reduction of cable volume
- Virtual Media (VM) capabilities, configurable for analog (local) or digital (remote) connectivity
- smart card/Common Access Card (CAC) capability
- true serial capability through Secure Shell (SSH) and Telnet
- enhanced video resolution support, up to 1600 x 1200 or 1680 x 1050 (widescreen) native from target to remote
- optional dual power models for redundancy
- optional support for managing intelligent power devices
- dual independent local port video paths (dedicated to ACI)

- dual stack IPv4 (DHCP) and IPv6 (DHCPv6 and stateless auto-configuration) for simultaneous access
- accessibility to target devices across 10/100/1000BaseT LAN ports.
- a MODEM port that supports V.34, V.90 or V.92-compatible modems that may be used to access the switch when an Ethernet connection is not available
- FIPS support

Reduce Cable Bulk

With server densities continually increasing, cable bulk remains a major concern for network administrators. The RCS significantly reduces KVM cable volume in the rack by utilizing the innovative Server Interface Pod (SIP) modules and single, industry-standard Unshielded Twisted Pair (UTP) cabling. This allows a higher server density while providing greater airflow and cooling capacity.

KVM Switching Capabilities

The RCS supports SIPs that are powered directly from the target device and provide Keep Alive functionality when the switch is not powered. The SIPs with CAT 5 design dramatically reduce cable clutter while providing optimal resolution and video settings. The built-in memory of the SIPs simplifies configuration by assigning and retaining unique device names and Electronic ID (EID) numbers for each attached device.

PS/2 and USB SIPs are available allowing direct KVM connectivity to devices. The USB2+CAC SIP is also available. The RCS is offered with 8, 16, or 32 Analog Rack Interface (ARI) ports for connecting SIPs. Utilizing the SIP, you can attach additional switches to expand your RCS system. This flexibility allows you to add capacity as your data center grows.

Multiplatform Support

The Dell SIPs are available for use with the RCS to support PS/2, USB, USB2, and USB2+CAC device environments. Using the OBWI in conjunction with these modules allows you to switch easily across platforms.

Interoperability with Avocent® IQ Module Intelligent Cabling may also be used to connect devices to the RCS. PS/2, USB, Sun®, and serial module options are available. For more information, please refer to the appropriate Avocent installer/user guide for your product or visit avocent.com/manuals for more information..

True Serial Capabilities

The RCS supports SIPs that provide true serial capabilities through Telnet. With a SIP, you can launch an SSH session or launch a serial viewer from the OBWI to connect to serial targets that are connected to an RCS.

Local and Remote User Interfaces

You can use the local user interface (local UI) by connecting directly to the local port to manage the RCS. You can also use the remote OBWI to manage your switch. The OBWI is web browser based and is launched directly from the switch, and any devices connected to the switch are automatically detected.

Virtual Media and Smart Card-capable Switches

The RCS allows you to view, move, or copy data located on virtual media to and from any target device. You can manage remote systems more efficiently by allowing operating system installation, operating system recovery, hard drive recovery or duplication, BIOS updating, and target device backup.

The RCS also allows you to use smart cards in conjunction with your switch system. Smart cards are pocket-sized cards that store and process information. Smart cards such as the CAC can be used to store identification and authentication to enable access to computers, networks, and secure rooms or buildings.

Virtual media and a smart card reader can be connected directly to the USB ports on the switch. In addition, virtual media and smart card readers may be connected to any remote workstation that is running the remote OBWI, Dell RCS software, or Avocent management software and is connected to the switch using an Ethernet connection.



NOTE: To open a virtual media or smart card session with a target device, you must first connect the target device to a switch using a SIP.

On-board Web Interface

The OBWI provides similar management functions as the RCS software, but does not require a software server or any installation. The OBWI is launched directly from the switch, and any servers connected to the RCS are automatically detected. You can use the OBWI to configure the RCS from a web browser. Launch the Viewer from the OBWI to establish KVM and virtual media sessions to target devices. The OBWI also supports LDAP authentication, which allows permissions for multiple RCSs to be managed through a single interface.

Access the Switch Using a Standard TCP/IP Network

The switch provides agentless remote control and access. No special software or drivers are required on the attached servers or client.



NOTE: The client connects to the switch using an Internet browser.

You can access the switch and all attached systems via Ethernet or using a V.34, V.90, or V.92 modem from a client. The clients can be located anywhere a valid network connection exists.

Encryption

The RCS supports 128-bit SSL(ARCFOUR), as well as AES, DES, and 3DES encryption of keyboard/mouse, video, and virtual media sessions.

Video

The RCS provides optimal resolution for analog VGA, SVGA, and XGA video. You can achieve resolutions up to 1600 x 1200 or 1680 x 1050 (widescreen), depending on the length of cable separating your switch and servers.

Flash Upgradeable

Upgrade your RCS and SIPs at any time to ensure you are always running the most current firmware version available. Flash Upgrades can be initiated through the OBWI or the serial console. The RCS can be configured to perform automatic firmware upgrades of SIPs. See "Upgrading RCS Firmware" on page 52 for more information.

Tier Expansion

The RCS features allow you to tier additional Dell RCSs from each of the Analog Rack Interface (ARI) port on the switch. The tiered switches are attached in the same manner as any device. This additional tier of units allows you to attach up to 1024 servers in one system. See "Adding a Tiered Switch" on page 31.

Avocent Management Software Plug-in

Avocent management software may be used with the switch to allow IT administrators to remotely access, monitor, and control target devices on multiple platforms through a single, web-based user interface. For more information, see the Technical Bulletin for the Avocent management software.

FIPS cryptographic module

The RCS switches support FIPS 140-2 Level 1 cryptographic security requirements. The FIPS mode of operation can be enabled or disabled via the OBWI or local port and executed after a reboot. When FIPS is enabled, a reboot of the switch requires approximately two additional minutes to complete a FIPS mode integrity check. Also, when FIPS is enabled, if the keyboard, mouse or video encryption is set to 128-bit SSL (ARCFOUR) or DES, the encryption level is automatically changed to the encryption level AES.



NOTE: The FIPS mode of operation is initially disabled and must be enabled to operate.



NOTE: The Setup port factory default setting will automatically disable the FIPS module.



NOTE: The FIPS mode can be changed via the DSView software plug-in.

RCS switches use an embedded FIPS 140-2 validated cryptographic module (Certificate #1051) running on a Linux PPC platform per FIPS 140-2 Implementation Guidance section G.5 guidelines.

The FIPS mode can be enabled/disabled via the OBWI, Local Port, or DSView plug-in. A reboot is required to enable or disable FIPS mode. A firmware upgrade to this version or setting the state to the default state (Setup Port menu) will disable FIPS mode.

In FIPS mode, encryption ciphers are restricted to AES or 3DES. When FIPS is enabled, if the Keyboard/Mouse or Video encryption is set to 128-bit SSL or DES, the encryption level is automatically changed to AES. With FIPS enabled, these files are saved (or restored) using a FIPS compatible algorithm, AES. When FIPS is disabled, the User Database and Appliance Configuration files saved from or restored to the appliance as external files are encrypted (or decrypted) using DES.

This is true even when the user does not fill in the Password parameter in the Save (or Load) dialog on the OBWI, in which case a default OEM password is used for encryption or decryption.

One result of enabling the FIPS module is to render previously saved User Database and Appliance Configuration files incompatible. In this case, you may temporarily disable the FIPS module, reboot the appliance, restore the previously saved database or configuration file, re-enable the FIPS module, reboot, and then save the file externally again while the FIPS module is enabled. The new saved external file will be compatible with the appliance as long as the appliance is running with FIPS mode enabled.

The opposite situation is also true, in that database and configuration files saved with FIPS module enabled are not compatible for restoring to an appliance without the FIPS module enabled or an appliance with older firmware not supporting the FIPS module.

Sample Configuration

Figure 1.1: Example RCS Configuration

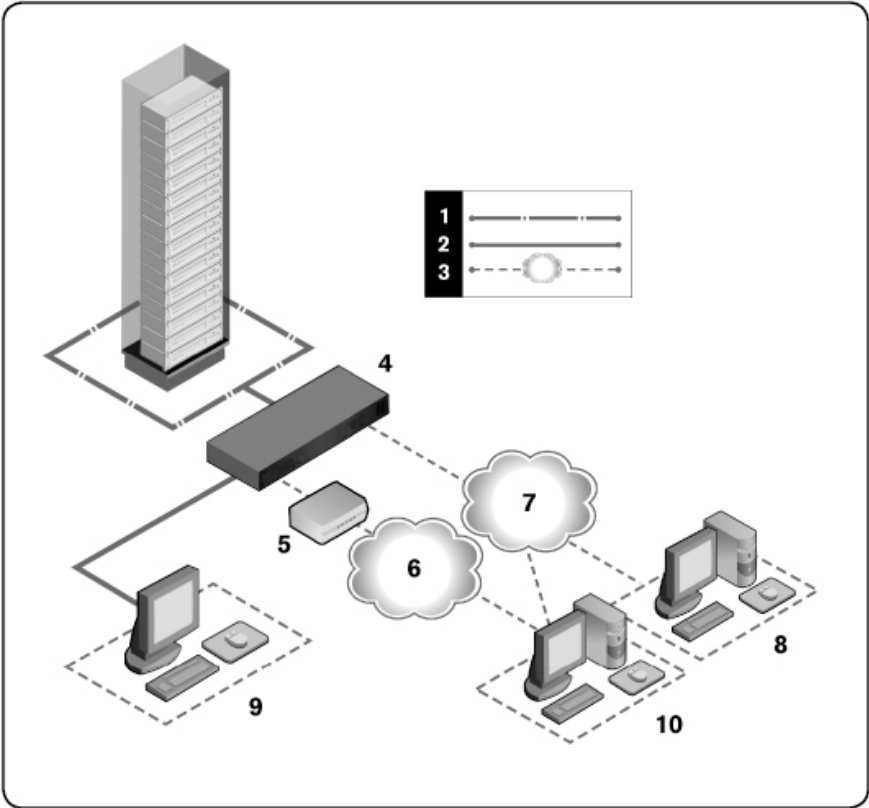

Table 1.1: Descriptions for Figure 1.1

Number	Description	Number	Description
1	UTP connection	6	Telephone network
2	KVM connection to the RCS	7	Ethernet
3	Remote IP connection	8	Avocent Management Software Server
4	RCS	9	Analog User (local UI)
5	Modem	10	Digital user (computer with Internet browser for a remote OBWI or Dell RCS software)

Safety Precautions

Use the following safety guidelines to help ensure your own personal safety and to help protect your system and working environment from potential damage.

⚠ CAUTION: The power supplies in your system may produce high voltages and energy hazards, which can cause bodily harm. Only trained service technicians are authorized to remove the covers and access any of the components inside the system. This warning applies to Dell™ Remote Console Switch, Dell™ PowerEdge™ servers, and Dell PowerVault™ storage systems.

This document pertains only to the Dell 1082DS/2162DS/4322DS Remote Console Switch. You should also read and follow the additional safety instructions.

- Dell Remote Console Switch User's Guide
- Dell Safety Sheet

- Dell RTF Regulatory Tech Bulletin

General

- Observe and follow service markings.
- Do not service any product except as explained in your system documentation.
- Opening or removing covers that are marked with the triangular symbol with a lightning bolt may expose you to electrical shock.
- Components inside these compartments should be serviced only by a trained service technician.
- This product contains no serviceable components. Do not attempt to open.

If any of the following conditions occur, unplug the product from the electrical outlet and replace the part or contact your trained service provider:

- The power cable, extension cable, or plug is damaged.
 - An object has fallen into the product.
 - The product has been exposed to water.
 - The product has been dropped or damaged.
 - The product does not operate correctly when you follow the operating instructions.
- Keep your system away from radiators and heat sources. Also, do not block cooling vents.
 - Do not spill food or liquids on your system components, and never operate the product in a wet environment. If the system gets wet, see the appropriate section in your troubleshooting guide or contact your trained service provider.
 - Use the product only with approved equipment.
 - Allow the product to cool before removing covers or touching internal components.

- Operate the product only from the type of external power source indicated on the electrical ratings label. If you are not sure of the type of power source required, consult your service provider or local power company.



NOTE: To help avoid damaging your system, be sure the voltage selection switch (if provided) on the power supply is set for the voltage that most closely matches the AC power available in your location. Also be sure that your monitor and attached devices are electrically rated to operate.

- Be sure that your monitor and attached devices are electrically rated to operate with the power available in your location.
- Use only power cables provided with this product.
- To help prevent electric shock, plug the system and peripheral power cables into properly grounded electrical outlets. These cables are equipped with three-prong plugs to help ensure proper grounding. Do not use adaptor plugs or remove the grounding prong from a cable.
- Observe extension cable and power strip ratings. Make sure that the total ampere rating of all products plugged into the power strip does not exceed 80 percent of the ampere ratings limit for the power strip.
- To help protect your system from sudden, transient increases and decreases in electrical power, use a surge suppressor, line conditioner, or uninterruptible power supply (UPS).
- Position system cables and power cables carefully. Route cables so that they cannot be stepped on or tripped over. Be sure that nothing rests on any cables.
- Do not modify power cables or plugs. Consult a licensed electrician or your power company for site modifications. Always follow your local/national wiring rules.

LAN Options

- Do not connect or use during a lightning storm. There may be a risk of electrical shock from lightning.

- Never connect or use in a wet environment.

Installation

The RCS transmits KVM and serial information between operators and target devices connected to the switch over a network using either an Ethernet or modem connection. The RCS uses TCP/IP for communication over Ethernet. For the best system performance, use a dedicated, switched 100BaseT or 1000BaseT network. You can also use 10BaseT Ethernet.

The RCS uses the Point-to-Point Protocol (PPP) for communication over a V.34, V.90, or V.92 modem. You can perform KVM and serial switching tasks by using the OBWI or the Avocent management software. For more information on the Avocent management software, visit <http://www.avocent.com>.

The RCS box includes the RCS, RCS software, and the OBWI. You may choose to use either the RCS software or the OBWI to manage your system. The OBWI manages a single RCS and its connections, while the RCS software can manage multiple switches and their connections. If you plan to use only the OBWI, you do not need to install the RCS software.



NOTE: The RCS software can be used to manage some switches. For more information, please refer to the appropriate installer/user guide for your product.



NOTE: Please ensure that all your RCSs have been upgraded to their most recent version of Firmware. For information on upgrading an RCS through the OBWI, refer to "RCS Tools" on page 52.

RCS Quick Setup

The following is a quick setup list. To begin by mounting the RCS in a rack and for detailed installation instructions, see "Getting Started" on page 15.

- 1 Adjust mouse acceleration on each server to Slow or None.
- 2 Install the RCS hardware, and connect a Server Interface Pod (SIP) or Avocent® IQ module to each server or tiered switch. Connect each SIP or Avocent IQ module to the RCS with CAT 5 cabling and connect the keyboard, monitor, and mouse connectors to the analog port of the RCS.
- 3 Connect the local port peripherals to the appropriate ports on the back panel of the RCS and set up the network configuration. The IP address can be set here or from the RCS software. Dell recommends using a static IP address for ease of configuration.
- 4 Using the local port, input all server names using the OBWI interface.

To set up the RCS software (see the RCS Software User's Guide):

- 1 Install the RCS software on each client workstation.
- 2 From one client workstation, launch the RCS software.
- 3 Click the **New RCS task** button to add the new switch to the RCS software database. If you configured the IP address as described above, select **Yes**, the product already has an IP address, otherwise select **No**, the product does not have an IP address.

RCS software will find the RCS and all SIPs connected to it and display the names in the Explorer.



NOTE: In addition to adding and managing Dell RCSs using the RCS software, you can add and manage some Avocent switches.

- 4 Set properties and group servers as desired into locations, sites, or folders through the Explorer.
- 5 Create user accounts through the OBWI. See "Setting Up User Accounts" on page 77 for more information.
- 6 Once one client workstation is set up, select **File - Database - Save** to save a copy of the database with all the settings.
- 7 From the second client workstation, click **File - Database - Load** and browse to find the file you have saved. Select the file and click Load.

- 8 If the local user adds, deletes, or renames any SIPs after you have loaded this file, you can resynchronize your local switch by selecting the RCS and clicking **Resync**. To control a connected server, select it in the Explorer and click the **Connect Video** task button to launch a server session in the Viewer.
- 9 Adjust the resolution (select View - Scaling) and quality (select View - Color) of the server video in the Viewer.

Getting Started

The following items are supplied with the Remote Console Switch. Before installing your RCS, locate the necessary items for proper installation.

- Remote Console Switch
- Jumper Cord(s)
- 0U Mounting Bracket
- 1U Mounting Bracket Hardware Kit (two additional rails that are pre-mounted to the RCS are included in the kit assembly)
- Cable and Adaptors for SETUP and MODEM
- Remote Console Switch System User's Guide on CD
- Dell Safety Sheet
- Dell RTF Regulatory Tech Bulletin

Additional Items Needed:

- One Dell SIP or Avocent IQ module per attached device
- One CAT 5 patch cable per attached device (up to 45 meters)

Optional Items:

- V.34, V.90, Or V.92-compatible Modem and cables
- Power Control Device(s)
- Port Expansion Module (PEM)



NOTE: You cannot open a virtual media session or a CAC session if the server is connected via a PEM.

Setting up Your Network

The switch uses IP addresses to uniquely identify the switch and the target devices. The RCS supports both Dynamic Host Configuration Protocol (DHCP) and static IP addressing. Make sure that an IP address is reserved for each switch and that each IP address remains static while the switch is connected to the network.

Keyboards

A USB keyboard and mouse may be connected to the analog port of the RCS.



NOTE: The RCS also supports the use of multiple keyboards and multiple mice on the analog port. The use of more than one input device simultaneously, however, may produce unpredictable results.

Rack Mounting the RCS

You may either place the RCS on the rack shelf or mount the switch directly into a 19" wide, EIA-310-E compliant rack (four-post, two-post, or threaded methods). The Dell ReadyRails™ system is provided for 1U front-rack, 1U rear-rack, and two-post installations. The ReadyRails system includes two separately packaged rail assemblies and two rails that are shipped attached to the sides of the RCS. In addition, one mounting bracket is provided for 0U configurations, and one blanking panel is provided for rear-rack installations.



WARNING: This is a condensed reference. Read the safety instructions in your **Safety, Environmental, and Regulatory Information booklet before you begin.**



NOTE: The illustrations in this document are not intended to represent a specific switch.

Rack Mounting Safety Considerations

- **Rack Loading:** Overloading or uneven loading of racks may result in shelf or rack failure, causing damage to equipment and possible personal injury.

Stabilize racks in a permanent location before loading begins. Mount components beginning at the bottom of the rack, then work to the top. Do not exceed your rack load rating.

- Power considerations: Connect only to the power source specified on the unit. When multiple electrical components are installed in a rack, ensure that the total component power ratings do not exceed circuit capabilities. Overloaded power sources and extension cords present fire and shock hazards.
- Elevated ambient temperature: If installed in a closed rack assembly, the operating temperature of the rack environment may be greater than room ambient. Use care not to exceed the 50°C maximum ambient temperature of the switch.
- Reduced air flow: Install the equipment in the rack so that the amount of airflow required for safe operation of the equipment is not compromised.
- Reliable earthing: Maintain reliable earthing of rack-mounted equipment. Pay particular attention to supply connections other than direct connections to the branch circuit (for example, use of power strips).
- Product should not be mounted with the rear panel facing in the downward position.

Installing the Dell ReadyRails™ System

The ReadyRails system is provided to easily configure your rack for installation of your RCS. The ReadyRails system can be installed using the 1U tool-less method or one of three possible 1U tooled methods (two-post flush mount, two-post center mount, or four-post threaded).

1U Tool-less Configuration (Four-post Square Hole or Unthreaded Round Hole)

- 1 With the ReadyRails flange ears facing outward, place one rail between the left and right vertical posts. Align and seat the rear flange rail pegs in the rear vertical post flange. In Figure 2.1, item 1 and its extractions illustrate how the pegs appear in both the square and unthreaded round holes.

Figure 2.1: 1U Tool-less Configuration

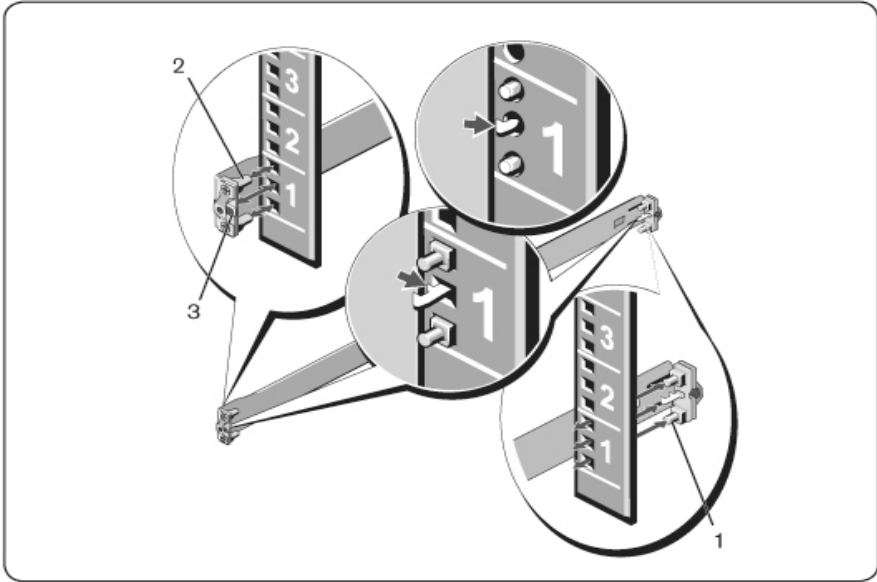

- 2 Align and seat the front flange pegs in the holes on the front side of the vertical post (item 2).
- 3 Repeat this procedure for the second rail.
- 4 To remove each rail, pull on the latch release button on each flange ear (item 3) and unseat each rail.

Two-post Flush-mount Configuration

- 1 For this configuration, the castings must be removed from the front side of each ReadyRails assembly (Figure 2.2, item 1). Use a Torx™ driver to remove the two screws from each front flange ear (on the device side of the rail) and remove each casting. Retain castings for future rack requirements. It is not necessary to remove the rear flange castings.

Figure 2.2: Two-post Flush-mount Configuration

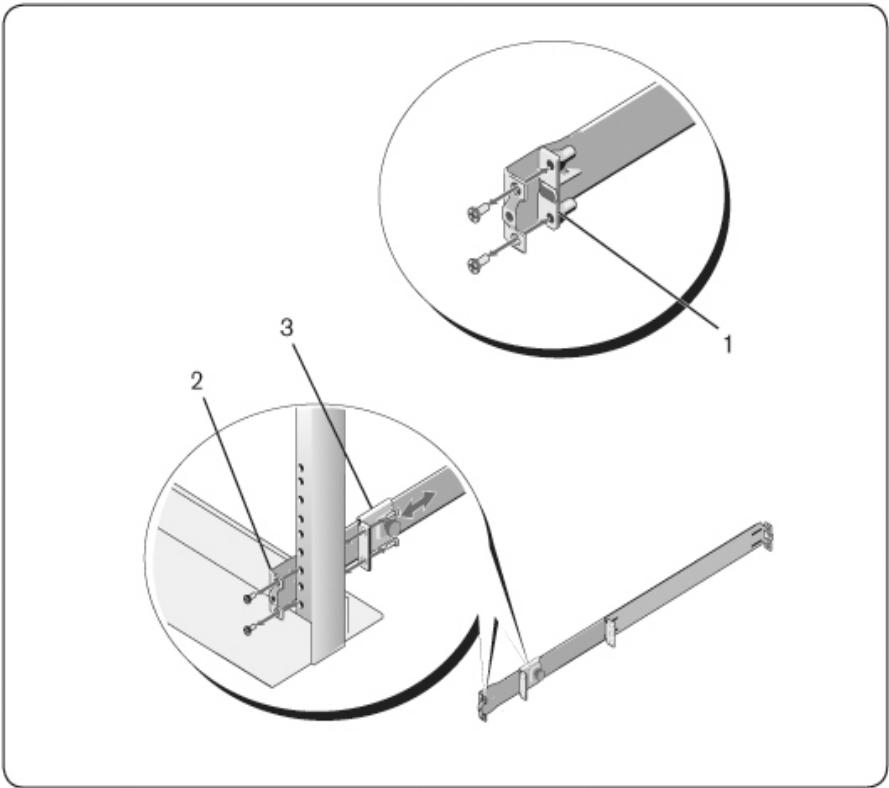

- 2 Attach one rail to the front post flange with two user-supplied screws (item 2).
- 3 Slide the plunger bracket forward against the vertical post and secure the plunger bracket to the post flange with two user-supplied screws (item 3).
- 4 Repeat this procedure for the second rail.

Two-post Center-mount Configuration

- 1 Slide the plunger bracket rearward until it clicks into place and secure the bracket to the front post flange with two user-supplied screws (Figure 2.3, item 1).

Figure 2.3: Two-post Center-mount Configuration

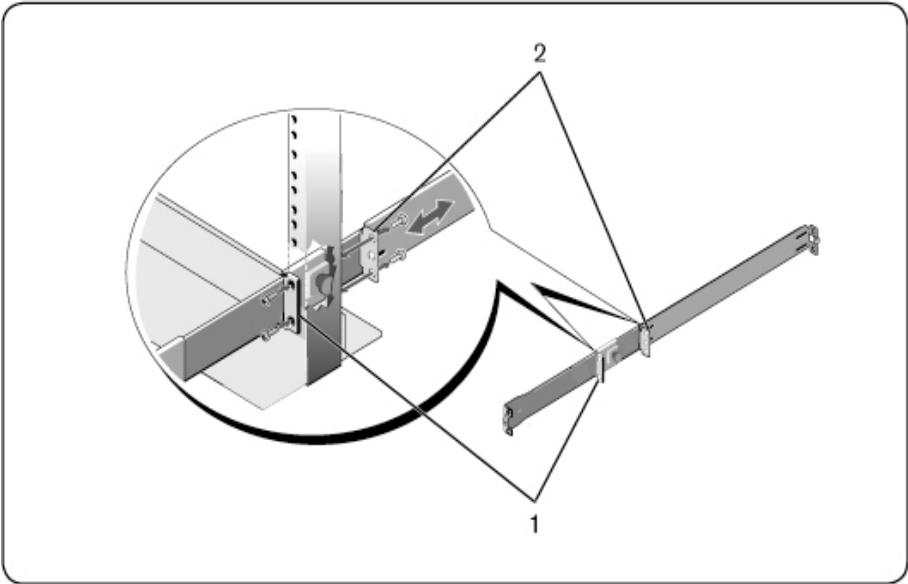

- 2 Slide the back bracket towards the post and secure it to the post flange with two user-supplied screws (item 2).
- 3 Repeat this procedure for the second rail.

Four-post Threaded Configuration

- 1 For this configuration, the flange ear castings must be removed from each end of the ReadyRails assemblies. Use a Torx™ driver to remove the two

screws from each flange ear and remove each casting (Figure 2.4, item 1). Retain castings for future rack requirements.

- 2 For each rail, attach the front and rear flanges to the post flanges with two user-supplied screws at each end (item 2).

Figure 2.4: Four-post Threaded Configuration

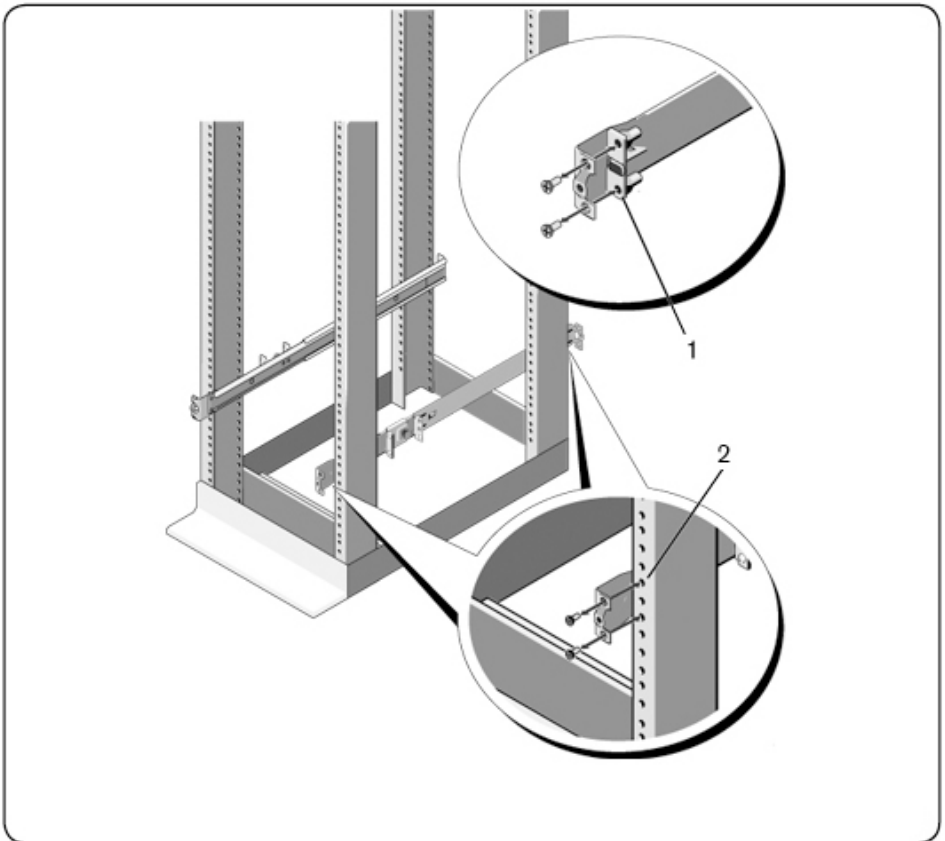

Installing the RCS

The switch may be mounted in the 1U rear-rack, 1U front-rack, 1U two-post (flush and center), and 0U configurations. The following are examples of 1U rear-rack, 1U front-rack, and 0U configurations. For 1U two-post (flush and center) configurations, you can slide the switch into the rails in the same manner as the four-post configurations.

1U Rear-rack Installation

- 1 Insert the ends of the rails that are attached to the switch into the ReadyRails assembly and push the switch into the rack (Figure 2.5, item 1).

Figure 2.5: 1U Rear-rack Installation

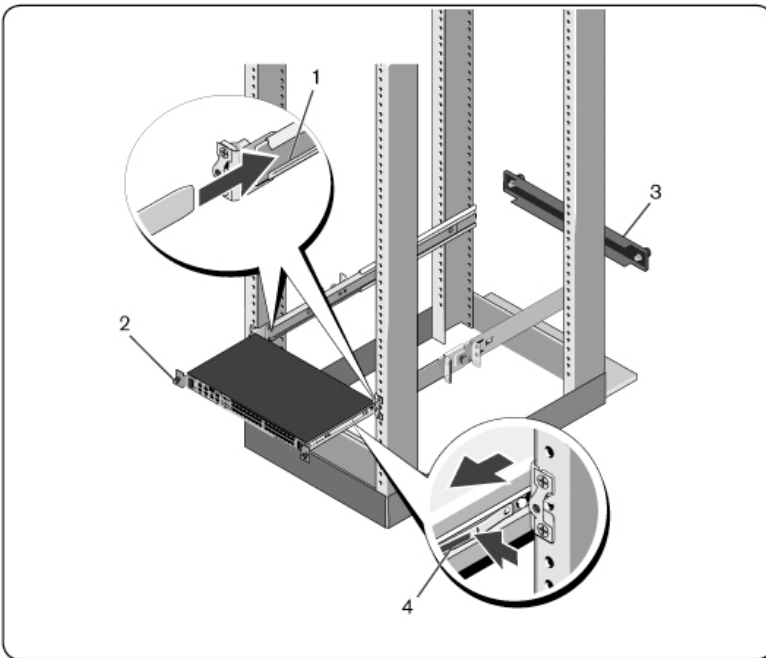

- 2 Secure each switch rail with the thumbscrew (item 2).
- 3 (Optional) Assemble the blanking panel to the rails on the front side of the rack and tighten the thumbscrews (item 3).

To remove the switch from the rack:

- 1 Unscrew the thumbscrews and pull the switch assembly out of the rack until the travel stops are reached. The travel stop position is intended to provide the opportunity to reposition the rail grip; it is not intended for service.
- 2 Locate the blue tabs on the sides of the switch rails (item 4).
- 3 Push the tabs inward and continue pulling the assembly until the switch rails are clear of the ReadyRails assemblies.

1U Front-rack Installation

Before installation, the rails that are attached to the switch must be re-configured.

- 1 On each switch rail, lift the tab under the front standoff and slide the rail forward as you lift the rail from the switch (Figure 2.6, item 1).

Figure 2.6: Rotating the Switch Rails

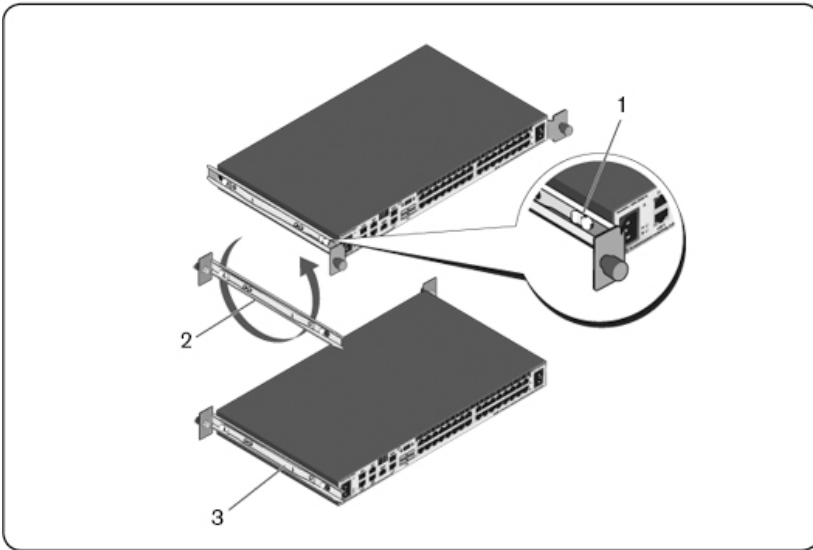

- 2 Rotate each rail 180° (item 2) and then reassemble each rail to the switch (item 3).
- 3 Refer to the 1U rear-rack instructions to insert and remove the switch assembly from the ReadyRails system.



NOTE: No blanking panel is required for this configuration.

0U RCS Installation

- 1 Align and assemble the 0U mounting bracket to the switch rails (Figure 2.7, item 1). Tighten the thumbscrews (item 2).
- 2 Insert the mounting bracket hooks into the rack holes and push down until the blue button pops out and locks the bracket into place.

Figure 2.7: 0U Installation

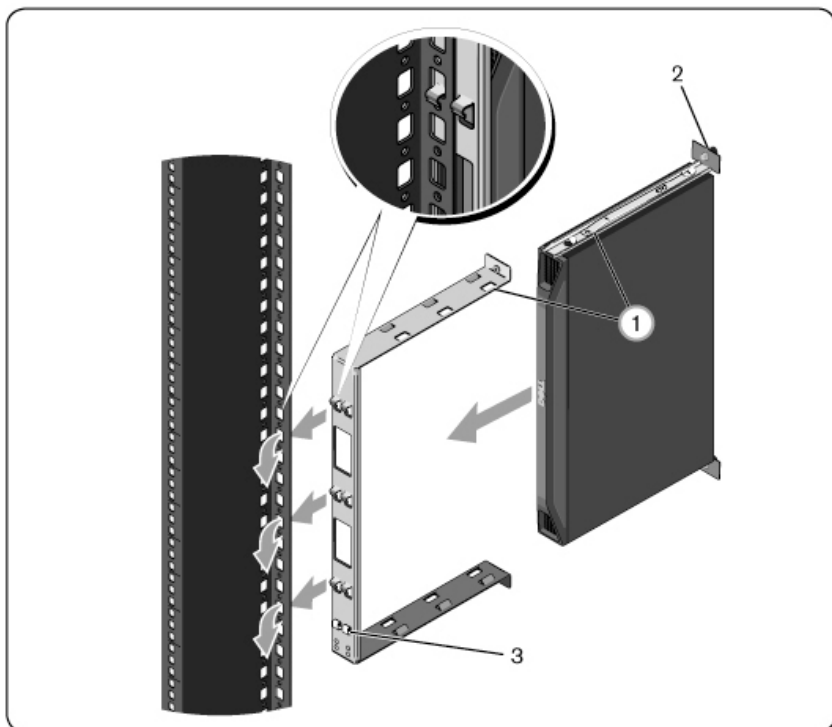

To remove the switch assembly, press the blue button (item 3) to unseat the bracket and then lift the assembly from the posts.

Connecting the RCS Hardware

The following diagram illustrates one possible configuration for your RCS hardware.

Figure 2.8: Basic RCS Configuration

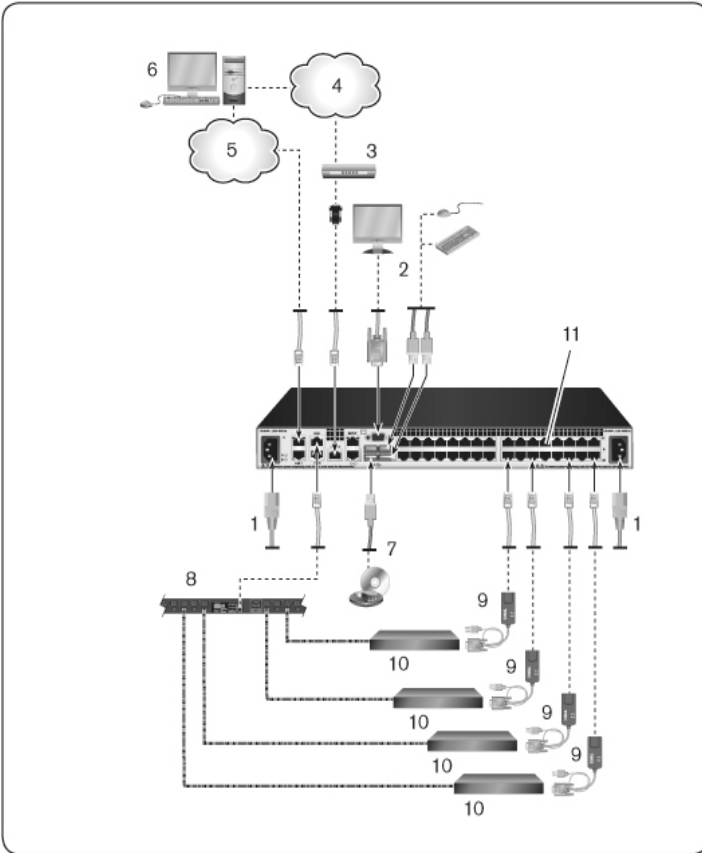



Table 2.1: Basic RCS Configuration Descriptions

Number	Description	Number	Description
1	Jumper cord	7	External virtual media
2	Analog user	8	Power control device

Number	Description	Number	Description
3	Modem	9	SIPs
4	Telephone network	10	Target devices
5	Network	11	RCS (32-port model shown)
6	Digital user		

To connect and turn on your switch:

 **CAUTION:** To reduce the risk of electric shock or damage to your equipment, do not disable the jumper cord grounding plug. The grounding plug is an important safety feature. Plug the jumper cord into a grounded (earthed) outlet that is easily accessible at all times. Disconnect the power from the unit by unplugging the jumper cord from either the power source or the unit.

 **NOTE:** If the building has 3-phase AV power, ensure that the computer and monitor are on the same phase to avoid potential phase-related video and/or keyboard problems.

 **NOTE:** The maximum supported cable length from switch to device is 30 meters.

- Do not disable the power grounding plug. The grounding plug is an important safety feature.
- Connect the jumper cord into a grounded (earthed) outlet that is easily accessible at all times.
- Disconnect the power from the product by unplugging the jumper cord from either the power source or the product.
- The AC inlet is the main disconnect for removing power to this product. For products that have more than one AC inlet, to remove power completely, all AC line cords must be disconnected.

- This product has no user serviceable parts inside the product enclosure. Do not open or remove product cover.

- 1 Connect your VGA monitor and USB keyboard and mouse cables to the appropriately labeled ports.
- 2 Connect one end of a UTP cable (4-pair, up to 150 ft/45 m) to an available numbered port. Connect the other end to an RJ-45 connector of a SIP.
- 3 Connect a SIP to the appropriate port on the back of a target device. Repeat steps 2 and 3 for all target devices you want to connect.



NOTE: When connecting to a Sun Microsystems target device, you must use a multi-sync monitor in the local port to accommodate Sun computers that support both VGA and sync-on-green or composite sync.

- 4 Connect a user-supplied UTP cable from the Ethernet network to a LAN port on the back of the RCS. Network users will access the RCS through this port. Plugging the redundant LAN ports to separate Ethernet switches provides additional redundancy in the event one Ethernet switch fails.
- 5 (Optional) The switch may also be accessed using an ITU V.92, V.90, or V.24-compatible modem. Connect one end of an RJ-45 cable to the MODEM port on the switch. Connect the other end to the supplied RJ-45 to DB-9 (male) adaptor, which then connects to the appropriate port on the back of the modem.



NOTE: Using a modem connection instead of a LAN connection will limit the performance capability of your switch.

- 6 (Optional) Connect a supported PDU to the RCS by connecting one end of a CAT 5 cable to the PDU1 port on the switch. Connect the other end to the PDU. Connect the power cords from the target devices to the PDU. Connect the PDU to a power source. Repeat this procedure for the PDU2 port to connect a second PDU, if desired.
- 7 Turn on each target device, then locate the jumper cord(s) that came with the switch. Connect one end to the power socket on the rear of the switch. Connect the other end into an appropriate power source. If using an RCS equipped with dual power, use the second jumper cord to connect to the

second power socket on the rear of the RCS, and plug the other end into a different power source.

 **NOTE:** Plug the redundant power supplies into separate branch circuits to provide additional redundancy in the event one external AC power source should go away.

8 (Optional) Connect the virtual media devices or smart card readers to any of the USB ports on the switch.

 **NOTE:** For all virtual media sessions, you must use a USB2 or USB2+CAC SIP.

Connecting a SIP

To connect a SIP to each server:

- 1 Locate the SIPs for your RCS.
- 2 If you are using a PS/2 SIP connection, attach the color-coded ends of the SIP cable to the appropriate keyboard, monitor, and mouse ports on the first server you will be connecting to this RCS. If you are using a USB connection, attach the plug from the SIP to the USB port on the first server you will be connecting to this RCS.
- 3 To the RJ-45 connector on the SIP, attach one end of the CAT 5 cabling that will run from your SIP to the RCS. See Figure 2.9.
- 4 Connect the other end of the CAT 5 cable to the desired Avocent Rack Interface (ARI) port on the back of your RCS.
- 5 Repeat steps 2-4 for all servers you wish to attach.

 **NOTE:** Power down the RCS before servicing. Always disconnect the jumper cord from the power source.

 **NOTE:** In addition to Dell SIPs, the RCS may also be connected to devices using Avocent IQ modules, including Sun and Serial IQ modules.

Figure 2.9: SIP Connection

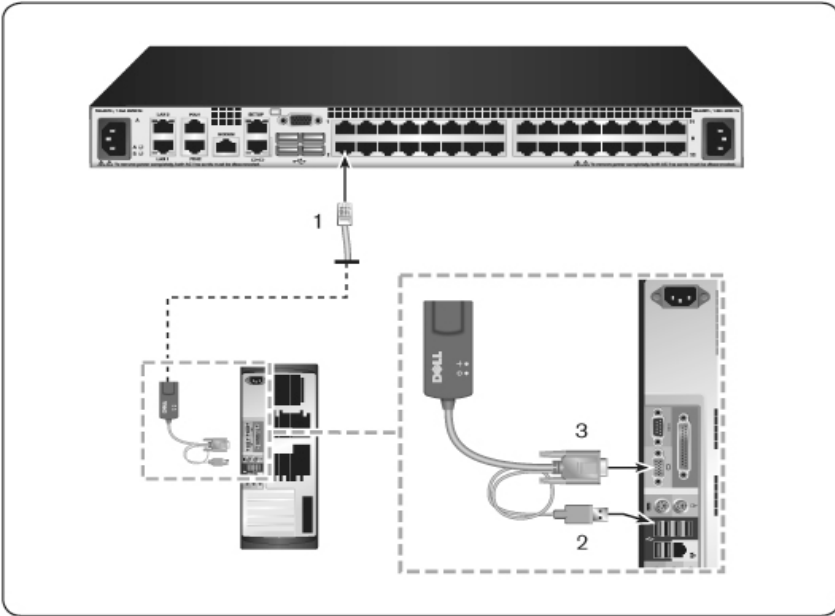

Table 2.2: Descriptions for Figure 2.9

Number	Description
1	CAT 5
2	USB Connection
3	VGA Connection

To connect a SIP to a serial device using a UTP connector:

- 1 Connect the SIP RJ-45 connector to the serial device.

-or-

Connect the SIP to an RJ-45 to 9-pin female adaptor. Connect the adaptor to the serial port of the serial device.

- 2 Connect one end of a UTP cable (4-pair, up to 150 ft/45 m) into an available numbered port on the rear of the switch. Connect the other end into the RJ-45 connector of the SIP.
- 3 Connect a USB-to-barrel power cord to the power connector on your SIP. Connect the USB connector on the USB-to-barrel power cord into any available USB port on the serial target device.

Adding a Tiered Switch



NOTE: The RCS does not support the EL80-DT.



NOTE: The M1000e Modular Enclosure is supported in a tiered configuration. Attach one end of a CAT5 cable to target port on RCS switch. Attach the other end to the Analog Console Interface (ACI) compatible RJ45 port on the iKVM module on the back of the M1000e chassis. Firmware upgrades to the components of the M1000e Modular Enclosure are not possible via this tiered configuration.

You can tier up to two levels of switches, enabling users to connect to up to 1024 servers. In a tiered system, each target port on the main switch will connect to the ACI port on each tiered switch. Each tiered switch can then be connected to a device with a SIP or Avocent IQ module.

To tier multiple switches:

- 1 Attach one end of a UTP cable to a target port on the switch.
- 2 Connect the other end of the UTP cable to the ACI port on the back of your tiered switch.
- 3 Connect the devices to your tiered switch.
- 4 Repeat these steps for all the tiered switches you wish to attach to your system.



NOTE: The system will automatically “merge” the two switches. All switches connected to the tiered switch will display on the main switch list in the local UI.



NOTE: The switch supports one tiered switch per target port of the main switch. You cannot attach a switch to the tiered switch.



NOTE: When cascading with an RCS, an 8-port or 16-port analog console switch is not supported as the primary unit in a tiered configuration. The RCS must be the primary unit.

Figure 2.10: Tiering the RCS With a UTP Analog Switch

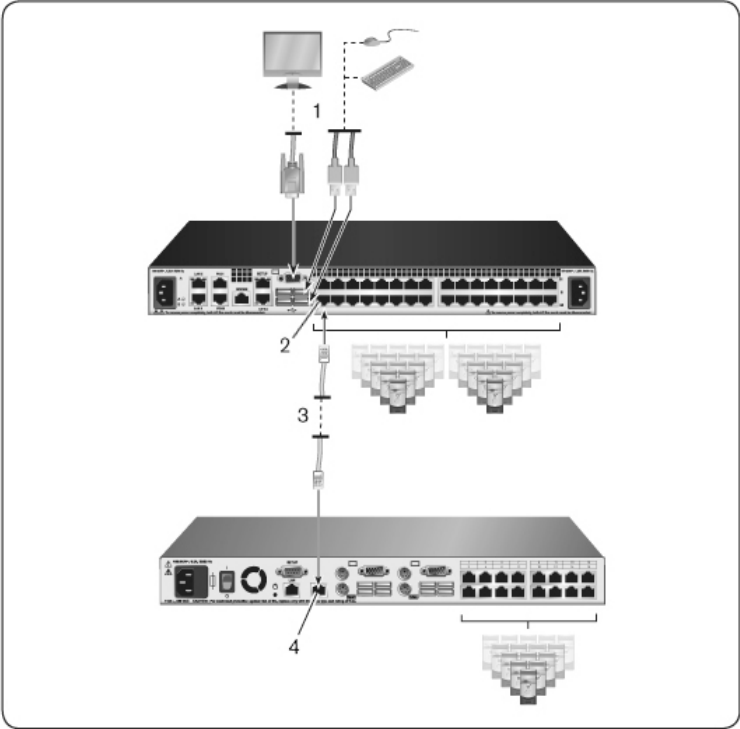

Table 2.3: Descriptions for Figure 2.10

Number	Description
1	Local User
2	ARI Connection
3	UTP Connection
4	ACI Connection

Cascading with Legacy Switches

To add a legacy switch (optional):

- 1 Mount the switch into your rack. Locate a UTP cable to connect your RCS to the legacy switch.
- 2 Attach one end of the UTP cabling to the ARI port on the Console Switch.
- 3 Connect the other end of the UTP cable to a PS/2 SIP.
- 4 Connect the SIP to your legacy switch according to the switch manufacturer's recommendations.
- 5 Repeat steps 1-4 for all the legacy switches you wish to attach to your switch.



NOTE: The RCS supports only one switch per ARI port. You cannot cascade another switch under this first switch.



NOTE: When cascading with an RCS, an 8-port or 16-port analog console switch is not supported as the primary unit. The RCS must be the primary unit.

Figure 2.11: Cascading Legacy Switches

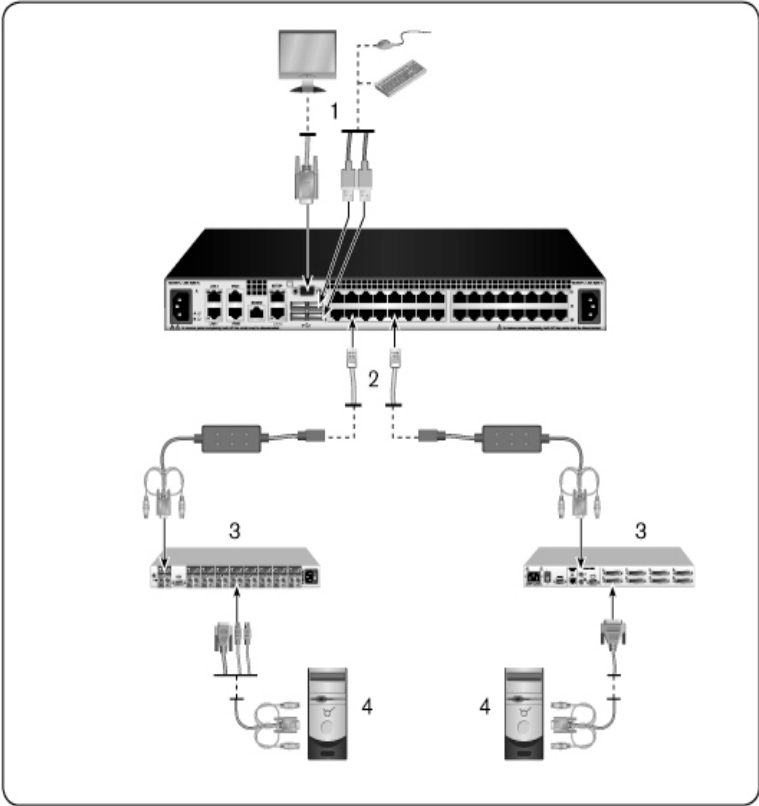

Table 2.4: Descriptions for Figure 2.11

Number	Description
1	Local User
2	ARI Connection

Number	Description
3	PS2 Connection
4	Target Connection

Adding a PEM (Optional)

A Port Expansion Module (PEM) allows you to expand each ARI port to accommodate up to eight devices instead of one. See the following figure and figure description table.



NOTE: The PEM operates passively. Therefore, once a user accesses a device attached to a PEM, any subsequent users attempting to access any of the devices attached to that PEM will be blocked.



NOTE: The use of VM or CAC SIPs behind a PEM is not supported.



NOTE: True Serial SIP does not work behind PEM.

To add a PEM (optional):

- 1 Mount the PEM into your rack. Using up to nine UTP cables, one connects your RCS to the PEM, and the other eight connect the PEM to the SIP attached to each device.
- 2 Attach one end of the UTP cabling that will run between your PEM and the RCS to the RJ-45 connector slightly separated from the other connectors on the PEM. Connect the remaining end of the UTP cable to the desired ARI port on the back of your RCS.
- 3 To one of the eight RJ-45 connectors grouped on the back of the PEM, attach the UTP cabling that will run between your PEM and each device's SIP.
- 4 Connect the other end of the UTP cable to the first SIP.
- 5 Repeat steps 3-4 for all devices you wish to attach.

Figure 2.12: RCS Configuration With a PEM

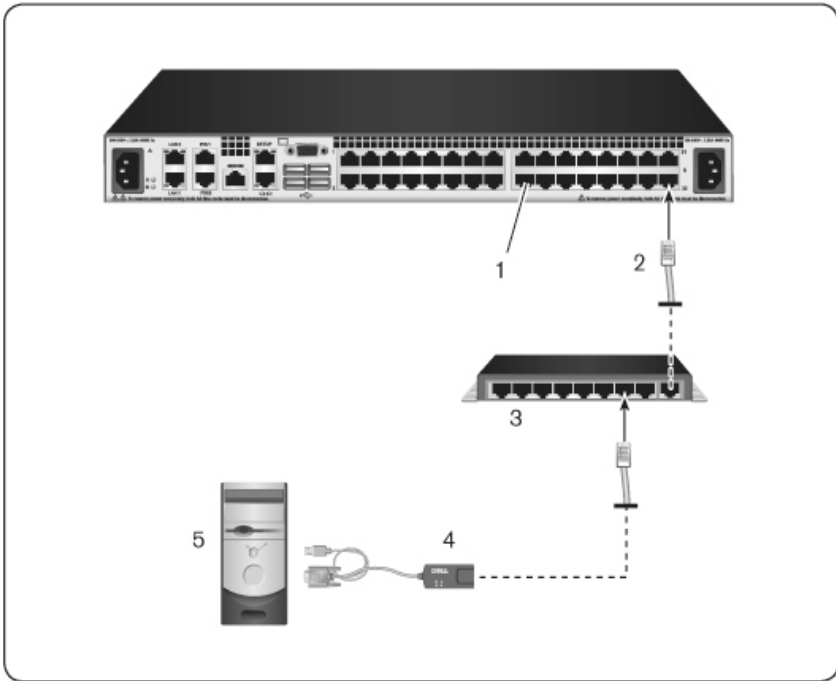

Table 2.5: Descriptions for Figure 2.12

Number	Description
1	ARI Port
2	UTP
3	PEM
4	SIP or Avocent IQ Module
5	Server

Configuring the Remote Console Switch

Once all physical connections have been made, you will need to configure the switch for use in the overall switch system. This can be accomplished in two ways.

To configure the switch using Avocent management software, see the applicable Avocent Installer/User Guide for detailed instructions.

To configure the switch using the local UI:

See "Network Settings" on page 55 for detailed instructions on using the local UI to configure initial network setup.

Setting up the Built-in Web Server

You can access the switch using the embedded web server that handles most day-to-day switch tasks. Before using the web server to access the switch, first specify an IP address through the SETUP port on the back panel of the switch or local UI. See Chapter 3 for detailed instructions on using the switch user interface.

Connecting to the OBWI Through a Firewall

For switch installations that use the OBWI for access, the following ports must be opened in a firewall if outside access is desired.

Table 2.6: OBWI Ports With a Firewall

Port Number	Function
TCP 22	Used for SSH for serial sessions to a SIP.
TCP 23	Used for Telnet (when Telnet is enabled).
TCP 80	Used for the initial downloading of the Video Viewer. The RCS Admin can change this value.

Port Number	Function
TCP 443	Used by the web browser interface for managing the switch and launching KVM sessions. The RCS Admin can change this value.
TCP 2068	Transmission of KVM session data (mouse & keyboard) or transmission of video on switches.
TCP/UDP 3211	Discovery.
TCP 389	(Optional) Used by LDAP Directory Services; standard access port
TCP 636	(Optional) Used by LDAP Directory Services; Secure/SSL port
TCP 3268	(Optional) Used by Microsoft Active Directory Services; standard access port
TCP 3269	(Optional) Used by Microsoft Active Directory Services; Secure/SSL access port

The following figure and table provide a typical configuration, where the user's computer is located outside of the firewall and the switch resides inside the firewall.

Figure 2.13: Typical RCS Firewall Configuration

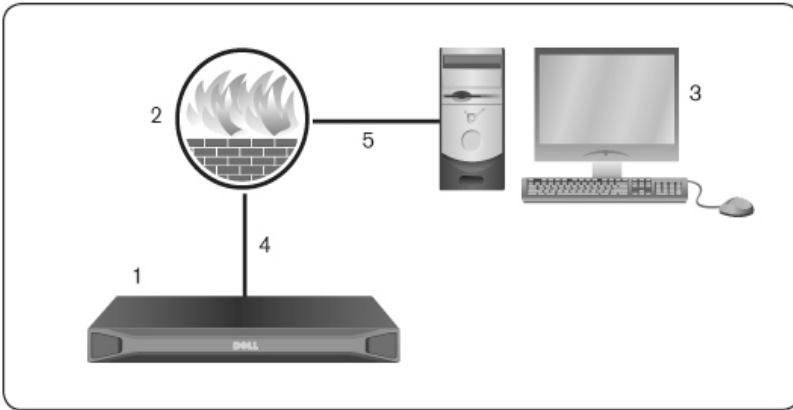

Table 2.7: Descriptions for Figure 2.13

Number	Description
1	RCS
2	Firewall
3	User's computer
4	Firewall forwards HTTP requests and KVM traffic to the switch
5	User browses to firewall's external IP address

To configure the firewall:

To access the switch from outside a firewall, configure your firewall to forward ports 22, 23 (if telnet is enabled), 80, 443, 2068, and 3211 from its external interface to the KVM switch through the firewall's internal interface. Consult the manual for your firewall for specific port forwarding instructions.



NOTE: Ports 80 and 443 can be reconfigured by an administrator.

For information on launching the OBWI, see "OBWI" on page 45.

Verifying the Connections

Rear Panel Ethernet Connection LEDs

On the RCS, the rear panel features two LEDs indicating the Ethernet LAN1 connection status and two LEDs indicating the Ethernet LAN2 connection status.

- The green LEDs illuminate when a valid connection to the network is established and blink when there is activity on the port.
- The bi-color LEDs may illuminate either green or amber.
 - They illuminate green when the communication speed is 1000M.
 - They illuminate amber when the communication speed is 100M.
 - They are not illuminated when the communication speed is 10M.

Rear Panel Power Status LEDs

The rear panel of each RCS has one for each power supply. There are two Power LEDs for dual power models (16-port and 32-port) and only one LED for the 8-port model. The LED(s) illuminate green when the switch is turned on and operating normally.

- The LED is off if the power supply does not have power or has failed.
- The LED illuminates when the unit is ready.
- The LED blinks when the switch is booting or an upgrade is in progress.
- The LED blinks "SOS" if a fault condition occurs, such as power supply failure, elevated ambient temperature, or fan failure. The LED will continue to blink "SOS" as long as the failure persists.

The switch prevents a serial break from the attached device if the module loses power. However, a user can generate a serial break with the attached device by pressing **Serial Break** on the serial session viewer.

Adjusting Mouse Settings on Target Devices

Before a computer connected to the switch can be used for remote user control, you must set the target mouse speed and turn off acceleration. For machines running Microsoft® Windows® (Windows NT®, 2000, XP, Server 2003), use the default PS/2 mouse driver.

To ensure that the local mouse movement and remote cursor display remain in sync, mouse acceleration must be set to “none” for all user accounts accessing a remote system through a KVM switch. Mouse acceleration must also be set to “none” on every remote system. Special cursors should not be used and cursor visibility options, such as pointer trails, **Ctrl** key cursor location animations, cursor shadowing, and cursor hiding, should also be turned off.



NOTE: If you are not able to disable mouse acceleration from within a Windows operating system, or if you do not wish to adjust the settings of all your target devices, you may use the **Tools - Single Cursor Mode** command available in the Video Viewer window. This command places the Video Viewer window into an “invisible mouse” mode, which allows you to manually toggle control between the mouse pointer on the target system being viewed and the mouse pointer on the client computer.

Local and Remote Configuration

The RCS comes equipped with two “point-and-click” interfaces: a local user interface (local UI) and a remote OBWI. Using the configuration options provided by these interfaces, you can tailor the switch to your specific application, control any attached devices, and handle all basic KVM or serial switch needs.



NOTE: The local UI and remote OBWI are almost identical. Unless specified, all information in this chapter applies to both interfaces.

From either interface, you can launch two different kinds of sessions:

- The Video Viewer window allows you to control the keyboard, monitor, and mouse functions of individual target devices connected to the switch in real time. You may also use predefined global macros to perform actions within the Video Viewer window. For instructions on how to use the Video Viewer, see Chapter 4.
- The serial viewer window allows you to manage individual serial target devices either by using commands or scripts.

Local User Interface (UI)

The switch includes a local port on the back. This port enables you to connect a keyboard, monitor and mouse directly to the switch and use the local UI.

You can choose any of the following keystrokes to be configured to open the local UI or to switch between the local UI and an active session: <Print

Screen>, <Ctrl + Ctrl>, <Shift + Shift>, and <Alt + Alt>. The defaults are <PrintScreen> and <Ctrl-Ctrl>.

To launch the local UI:

- 1 Connect your monitor, keyboard and mouse cables to the switch. For more information, see "Connecting the RCS Hardware" on page 25.
- 2 Press any of the enabled keystrokes to launch the local UI.
- 3 If local UI authentication has been enabled, enter your username and password.



NOTE: If the switch has been added to an Avocent management software server, then the Avocent management software server will be accessed to authenticate the user. If the switch has not been added to an Avocent management software server, or if the Avocent management software server cannot be reached, then the switch local user database will be accessed to authenticate the user. The default local username is Admin, and there is no password. Usernames in the local user database are case-sensitive.

Attached target devices in the Local Port User Interface can be viewed and managed from two individual screens that are selected from the left navigational toolbar. For less than 20 targets, the Target List-Basic screen is recommended for navigation. For more than 20 attached target devices, the Target List-Full screen provides additional navigation tools. At the Target List-Full screen you can navigate by entering the page number, using the page navigation buttons, or using the filter. Either the Basic or Full screens can be set as the default screen for selecting target devices.

Filtering

You may filter the list of target devices by providing a text string that will be used to retrieve matching items. Filtering can provide a shorter, more exact list of items. When filtering is performed, the Name column is searched for the specified text string. The search is not case sensitive. When filtering, you may use an asterisk (*) before or after text strings as a wildcard. For example, typing **emailserver*** and clicking **Filter** will display items with emailserver at the beginning (such as emailserver, emailserverbackup).

OBWI

The switch OBWI is a remote, web browser based user interface. For details on setting up your system, see "Connecting the RCS Hardware" on page 25. The following table lists the operating systems and browsers that are supported by the OBWI. Make sure that you are using the latest version of your Web browser.

Table 3.1: Operating Systems Supported by the OBWI

Operating System	Browser	
	Microsoft®Internet Explorer version 6.0 SP1 and later	Firefox version 2.0 and later
Microsoft Windows 2000 Workstation or Server with Service Pack 2	Yes	Yes
Microsoft Windows Server® 2003 Standard, Enterprise, or Web Edition	Yes	Yes
Microsoft Windows Server® 2008 Standard, Enterprise, or Web Edition	Yes	Yes
Windows XP Professional with Service Pack 3	Yes	Yes
Windows Vista® Business with Service Pack 1	Yes	Yes

Operating System	Browser	
	Microsoft®Internet Explorer version 6.0 SP1 and later	Firefox version 2.0 and later
Red Hat Enterprise Linux® 4 and 5 Standard, Enterprise or Web Edition (Smart card may not be supported by the operating system)	No	Yes
Sun Solaris® 9 and 10 (Smart card may not be supported by the operating system)	No	Yes
Novell SUSE Linux Enterprise 10 and 11 (Smart card may not be supported by the operating system)	No	Yes
Ubuntu 8 Workstation (Smart card may not be supported by the operating system)	No	Yes

To log in to the switch OBWI:

- 1 Launch a web browser.
- 2 In the address field of the browser, enter the IP address or host name assigned to the switch you wish to access. Use `https://xxx.xx.xx.xx` or `https://hostname` as the format.



NOTE: If using IPv6 mode, you must include square brackets around the IP address. Use `https://[<ipaddress-]>` as the format.

- 3 When the browser makes contact with the switch, enter your username and password, then click **Login**. The switch OBWI will appear.



NOTE: The default username is Admin with no password.

To log in to the switch OBWI from outside a firewall, repeat the above procedure, entering the external IP address of the firewall instead.



NOTE: The RCS will attempt to detect if Java is already installed on your PC. If it is not, in order to use the on-board web interface, you will need to install it. You may also need to associate the JNLP file with Java WebStart.



NOTE: Using the on-board web interface requires using Java Runtime Environment (JRE) version 1.6.0_11 or higher.



NOTE: Once you have logged in to the on-board web interface, you will not have to log in again when launching new sessions unless you have logged out or your session has exceeded the inactivity timeout specified by the administrator.

Using the User Interfaces

After you have been authenticated, the user interface appears. You may view, access, and manage your switch, as well as specify system settings and change profile settings. The following figure shows the user interface window areas. Screen descriptions are provided in the following table.

Figure 3.1: User Interface Window

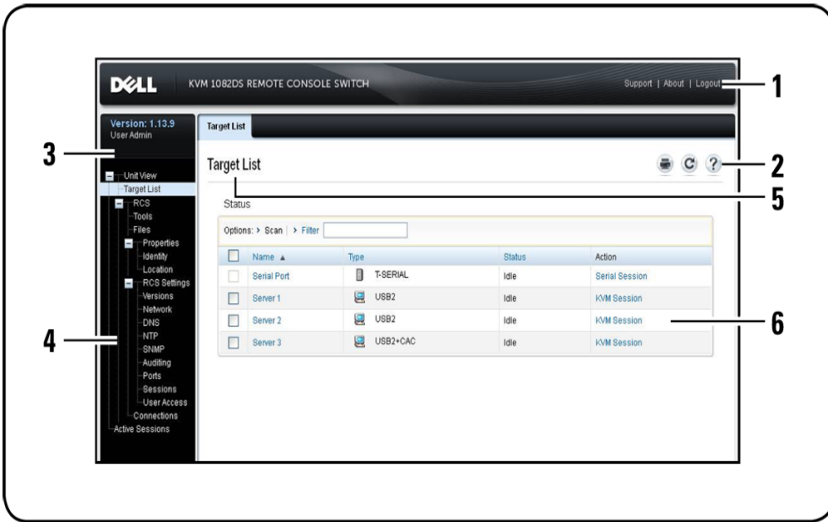



Table 3.2: User Interface Descriptions

Number	Description
1	Top option bar: Use the top option bar to contact Technical Support, view the software general information, or log out of an OBWI session.
2	Second option bar: Use this bar to print a web page, refresh the current web page or access the Help tool.
3	Version block: The firmware version of the product and the username of the user currently logged in appears on the left side of the top option bar.

Number	Description
4	Side navigation bar: Use the side navigation bar to select the information to be displayed. You can use the side navigation bar to display windows in which you can specify settings or perform operations.
5	Navigation tabs: The selected tab displays the system information in the content area. Some tabs provide sub tabs that can be clicked to display and revise details within a category.
6	Content area: Use the content area to display or make changes to the switch OBWI system.

Launching a Session

 **NOTE:** Java 1.6.0_11 or later is required to launch a session.

To launch a session:

- 1 From the side navigation bar, select **Target List**. A list of available devices will appear.
- 2 The applicable action, KVM Session or Serial Session, will be displayed in the Action column, and will depend on the target device that was selected to launch the session. If more than one action is available for a given target device, click the drop-down arrow and select the applicable action from the list.

If the target device is currently in use, you may be able to gain access by forcing a connection to the device if your preemption level is equal to or higher than the current user's.

The RCS also allows serial sessions to Serial SIPs via an external Telnet or SSH application such as PuTTY. Telnet and SSH sessions are only used to connect to Serial SIPs and cannot be used to access or manage RCS or KVM target devices.

To launch a serial session from a Telnet or SSH application:

- 1 Enter the RCS host IP address that the Serial SIP is connected to.
- 2 Enter <RCS-username>:<Serial-SIP-name>, for example, jsmith:router.
- 3 Enter the password for the RCS user.



NOTE: The Telnet feature default is disabled. To enable Telnet support, refer to "Configuring Serial Sessions" on page 77.

To switch to the active session from the local UI (local users only):

- 1 From the side navigation bar, select **Local Session**.
- 2 Select the **Resume Active Session** checkbox. The Video Viewer window will appear.

Scan Mode

In Scan mode, the switch scans multiple target devices. The scanning order is determined by placement of the target device in the list. You can also configure the amount of time before the scan moves to the next target device in the sequence.



NOTE: The Scan button is disabled if you are connected via modem.

To add target devices to the Scan list:

- 1 From the side navigation bar, select **Unit View - Target List** to open the Target Devices screen.
- 2 Select the checkboxes next to the names of the target devices you wish to scan.
- 3 Click **Scan**.

To configure Scan Time:

- 1 From the side navigation bar, select **Ports - Local Port UI** to open the Local Port UI Settings screen.
- 2 Under the Scan Mode heading, enter an amount of time in seconds (from 3-255) in the Scan Time field.

3 Click Save.

Viewing System Information

You can view switch and target device information from the following screens in the user interface.

Table 3.3: System Information

Category	Select This:	To View This:
RCS	Unit View - RCS - Tools	RCS name and type, and the RCS tools (Maintenance, Diagnostics, Certificates and Trap MIB)
	Unit View - RCS - Files	RCS Configuration, User Database, and Target Device
	Unit View - RCS - Properties - Identity	Part Number, Serial Number, and EID
	Unit View - RCS - Properties - Location	Site, Department, and Location
	Unit View - RCS Settings - Versions	Current Application and Boot versions
Target Device	Unit View - Target List	List of connected target devices, as well as the Name, Type, Status, and Action of each device Click on a target device to view the following additional information: Name, Type, EID, available session option, and the connection path

RCS Tools

From the Tools - Maintenance - Overview screen, you can view the appliance name and type. You can also perform basic appliance tasks.

Rebooting the RCS

To reboot the RCS:

- 1 From the side navigation bar, select the **Unit View - RCS - Tools - Maintenance - Overview** tab to open the Unit Maintenance screen.
- 2 Click **Reboot**.
- 3 A dialog box appears, warning you that all active sessions will be disconnected. Click **OK**.



NOTE: If you are using the local UI, the screen will be blank while the switch reboots. If you are using the remote OBWI, a message will appear to let you know that the interface is waiting on the appliance to complete the reboot.

Upgrading RCS Firmware

You can update your RCS with the latest firmware available.

After the Flash memory is reprogrammed with the upgrade, the switch performs a soft reset, which terminates all SIP sessions. A target device experiencing a SIP firmware update may not display, or may display as disconnected. The target device will appear normally when the Flash update is completed.

Attention: Disconnecting a SIP during a firmware update or cycling power to the target device will render the module inoperable and require the SIP to be returned to the factory for repair.

To upgrade the switch firmware:

- 1 From the side navigation bar, select the **Unit View - RCS - Tools - Maintenance - Upgrade** tab to open the Upgrade RCS Firmware window.
- 2 Click **Upgrade** to open the Upgrade Appliance Firmware.

- 3 Select one of the following methods from which to load the firmware file: **Filesystem**, **TFTP**, **FTP**, or **HTTP**.

 **NOTE:** The Filesystem option is only available on the remote OBWI.

- 4 If you selected Filesystem, select **Browse** to specify the location of the firmware upgrade file.

-or-

If you selected TFTP, enter the Server IP Address and Firmware File you wish to load.

-or-

If you selected FTP or HTTP, enter the Server IP Address and Firmware File you wish to load, as well as the User Name and User Password.

- 5 Click **Upgrade**.

Saving and Restoring RCS Configurations and RCS User Databases

You may save the switch configuration to a file. The configuration file will contain information about the managed appliance. You may also save the local user database on the switch. After saving either file, you may also restore a previously saved configuration file or local user database file to the switch.

To save a managed appliance configuration or user database of a managed appliance:

- 1 From the side navigation bar, click the **Unit View - RCS - Files** tab.
- 2 Click either the **RCS Configuration** tab or the **User Database** tab, then click the **Save** tab.
- 3 Select the file save method: **Filesystem**, **TFTP**, **FTP**, or **HTTP PUT**.
- 4 If you selected TFTP, enter the Server IP Address and Firmware Filename you wish to load.

-or-

If you selected FTP or HTTP, enter the Server IP Address, Username, User Password, and Firmware Filename you wish to load.

- 5 Enter an encryption password if you wish to encrypt the data before download.
- 6 Click **Download**. The Save As dialog box will open.
- 7 Navigate to the desired location and enter a name for the file. Click **Save**.

To restore a managed appliance configuration or user database of a managed appliance:

- 1 From the side navigation bar, click the **Unit View - RCS - Files** tab.
- 2 Click either the **RCS Configuration** tab or the **User Database** tab, then click the **Restore** tab.
- 3 Select the file save method: **Filesystem**, **TFTP**, **FTP**, or **HTTP**.
- 4 If you selected Filesystem, select **Browse** to specify the location of the firmware upgrade file.

-or-

If you selected TFTP, enter the Server IP Address and Firmware Filename you wish to load.

-or-

If you selected FTP or HTTP, enter the Server IP Address, User Name, User Password, and Firmware Filename you wish to load.

- 5 Click **Browse**. Navigate to the desired location and select the file name. Click **Upload**.
- 6 Enter the decryption password if the original file was encrypted.
- 7 After the success screen appears, reboot the managed appliance to enable the restored configuration. See "Rebooting the RCS" on page 52.

To recover from a Flash update failure:

If after a Flash procedure, the RCS does not boot into the new firmware version, you may use the following steps to revert to the previous firmware version.

- 1 Connect a serial cable to the SETUP port on the rear panel of the RCS.
- 2 Run a terminal program on the PC connected to the Setup port. The serial port settings should be: 9600 baud, 8 data bits, 1 stop bit, no parity, and no flow control.
- 3 Turn on the RCS.
- 4 In the terminal program, when the prompt "Hit any key to stop autoboot" appears, press any key. A menu will be displayed.
- 5 Enter <1> (Boot Alternate) and press <Enter>. The RCS will automatically reboot to the previous firmware version.
- 6 After the RCS reboots, you can attempt the Flash upgrade.

Network Settings



NOTE: Only switch administrators can make changes to the network dialog box settings. Other users will have view only access.

From the side navigation bar, click **Network** to display the General, IPv4, and IPv6 tabs.

To configure general network settings:

- 1 Click the **Network** tab, then click the **General** tab to display the RCS General Network Settings screen.
- 2 Select one of the following options from the LAN Speed drop-down menu: **Auto-Detect**, **10 Mbps Half Duplex**, **10 Mbps Full Duplex**, **100 Mbps Half Duplex**, **100 Mbps Full Duplex**, or **1 Gbps Full Duplex**.



NOTE: You must reboot if you change the Ethernet mode.

- 3 Select either **Enabled** or **Disabled** in the ICMP Ping Reply drop-down menu.
- 4 Verify or modify the HTTP or HTTPS ports. The settings will default to HTTP 80 and HTTPS 443.
- 5 Click **Save**.

To configure IPv4 network settings:

- 1 Click the **IPv4** tab to display the IPv4 Settings screen.
- 2 Click to fill or clear the **Enable IPv4** checkbox.
- 3 Enter the desired information in the Address, Subnet, and Gateway fields. IPv4 addresses are entered as the xxx.xxx.xxx.xxx dot notation.
- 4 Select either **Enabled** or **Disabled** from the DHCP drop-down menu.



NOTE: If you enable DHCP, any information that you enter in the Address, Subnet, and Gateway fields will be ignored.

- 5 Click **Save**.

To configure IPv6 network settings:

- 1 Click the **IPv6** tab to display the IPv6 Settings screen.
- 2 Click to fill or clear the **Enable IPv6** checkbox.
- 3 Enter the desired information in the Address, Subnet, and Prefix Length fields. IPv6 addresses are entered as the FD00:172:12:0:0:0:33 or abbreviated FD00:172:12::33 hex notation.
- 4 Select either **Enabled** or **Disabled** from the DHCP drop-down menu



NOTE: If you enable DHCPv6, any information that you enter in the Address, Gateway, and Prefix length fields will be ignored.

- 5 Click **Save**.

DNS Settings

You can choose to either manually assign the DNS server or to use the addresses obtained using DHCP or DHCPv6.

To manually configure DNS settings:

- 1 From the side navigation bar, select **DNS** to display the RCS DNS Settings screen.
- 2 Select **Manual**, **DHCP** (if IPv4 is enabled) or **DHCPv6** (if IPv6 is enabled).

- 3 If you selected **Manual**, enter the DNS Server numbers in the Primary, Secondary, and Tertiary fields.
- 4 Click **Save**.

NTP Settings

The switch must have access to the current time to verify that certificates have not expired. You can configure the switch to request time updates from the NTP. Refer to *Configuring the Network Time Protocol (NTP) Settings* in Chapter 5.

SNMP Settings

SNMP is a protocol used to communicate management information between network management applications and the switch. Other SNMP managers can communicate with your switch by accessing MIB-II. When you open the SNMP screen, the OBWI will retrieve the SNMP parameters from the unit.

From the SNMP screen, you can enter system information and community strings. You may also designate which stations can manage the switch as well as receive SNMP traps from the switch. If you select **Enable SNMP**, the unit will respond to SNMP requests over UDP port 161.

To configure general SNMP settings:

- 1 Click **SNMP** to open the SNMP screen.
- 2 Click to enable the **Enable SNMP** checkbox to allow the switch to respond to SNMP requests over UDP port 161.
- 3 Enter the system's fully qualified domain name in the Name field, as well as a node contact person in the Contact field.
- 4 Enter the Read, Write, and Trap community names. These specify the community strings that must be used in SNMP actions. The Read and Write strings only apply to SNMP over UDP port 161 and act as passwords

that protect access to the switch. The values can be up to 64 characters in length. These fields may not be left blank.

- 5 Type the address of up to four management workstations that are allowed to manage this switch in the Allowable Managers fields. Alternatively, you may leave these fields blank to allow any station to manage the RCS.
- 6 Click Save.

Auditing Event Settings

An event is a notification sent by the switch to a management station indicating that something has occurred that may require further attention.

To enable individual events:

- 1 Click **Auditing** to open the Events screen.
- 2 Specify the events that will generate notifications by clicking the appropriate checkboxes in the list.

-or-

Select or clear the checkbox next to Event Name to select or deselect the entire list.

- 3 Click Save.

Setting Event Destinations

You can configure audit events to be sent to SNMP trap destinations and Syslog servers. The events enabled on the Events screen are sent to all the servers listed on the Event Destination screen.

- 1 Click **Auditing** and the **Destinations** tab to open the Event Destinations screen.
- 2 Type the address of up to four management workstations to which this switch will send events in the SNMP Trap Destination fields, as well as up to four Syslog servers.

- 3 Click **Save**.

Ports - Configuring SIPs

From the switch, you can display a list of the attached SIPs, as well as the following information about each SIP: EID (electronic ID), Port, Status, Application, Interface Type, and USB Speed. You can click on one of the SIPs to view the following additional information: Switch Type, Boot Version, Application Version, Hardware Version, FPGA Version, Version Available, and Upgrade Status.

You can also perform the following tasks: delete offline SIPs, upgrade the SIP firmware, set the USB speed, or decommission the cables.

To delete offline SIPs:

- 1 From the side navigation bar, click **Ports - SIPs** to open the SIP screen.
- 2 Click **Delete Offline**.

Upgrading SIPs

The SIP Flash upgrade feature allows RCS Administrators to update the SIP with the latest firmware available. This update can be performed using the switch user interface or Avocent management software.

After the Flash memory is reprogrammed with the upgrade, the switch performs a soft reset, which terminates all SIP sessions. A target device experiencing a SIP firmware update may or may not display as disconnected. The target device will appear normally when the Flash update is completed.

If the RCS is configured to Auto-Upgrade SIPs, the SIPs will automatically update when the switch is updated. To update your switch firmware, see "RCS Tools" on page 52 or the Avocent management software Online Help. If issues occur during the normal upgrade process, SIPs may also be force-upgraded when needed.



NOTE: Check <http://www.dell.com> for firmware upgrade files.

To change the SIP Auto-Upgrade feature:

- 1 From the side navigation bar, click **Ports - SIPs** to open the SIPs screen.
- 2 Select the checkbox(es) next to the SIP(s) that you wish to upgrade and click **Enable Auto-Upgrade**.

Attention: Disconnecting a SIP during a firmware update or cycling power to the target device will render the module inoperable and require the SIP to be returned to the factory for repair.

To upgrade the SIP firmware:

- 1 From the side navigation bar, click **Ports - SIPs** to open the SIPs screen.
- 2 Select the checkbox(es) next to the SIP(s) that you wish to modify.
- 3 Select **Choose an operation** and select **Upgrade**.
- 4 If the settings are correct, click **Upgrade**.

To set the USB Speed:

 **NOTE:** This section only applies to the USB2 SIP.

- 1 From the side navigation bar, click **Ports - SIPs** to open the SIPs screen.
- 2 Select the checkbox(es) next to the SIP(s) that you wish to modify.
- 3 Select **Choose an operation** and select either **Set USB 1.1 Speed** or **Set USB 2.0 Speed**.

Power Device Settings

 **NOTE:** You must have Administrator privileges to change power control device settings.

 **NOTE:** Refer to www.dellkvm.com for a list of supported PDUs.

From the RCS Power Devices screen, you can view a list of connected power devices, as well as the following information about each power device: Name, Port, Status, Version, Model, Buzzer, Alarm, and Temperature. You can also select a power device, then select **Settings** to view the following details about

that power device: Name, Description, Status, Version, Sockets, Vendor Name, Model, and Input Feeds.

If a target device is connected to a power control device outlet, you can turn on, turn off or cycle (turn off, then turn on) the target device.

To turn on, turn off or power cycle a target device:

- 1 From the side navigation bar, click **Ports - Power Devices** to open the Power Devices screen.
- 2 Click the name of the unit you wish to configure and select **Outlet List**.
- 3 Select the checkbox to the left of the outlet(s) that you wish to configure.
- 4 Click **On**, **Off**, or **Cycle**, as desired.

To delete offline power devices:

- 1 From the side navigation bar, click **Ports - Power Devices** to open the Power Devices screen.
- 2 Click **Delete Offline**.

To change the minimum on time, off time or wake up state:

- 1 From the side navigation bar, click **Ports - Power Devices** to open the Power Devices screen.
- 2 Click the name of the unit you wish to configure and select **Outlets**.
- 3 Click the outlet name that you wish to modify.
- 4 Use the drop-down windows to alter the desired settings and click **Save**.

Associated Target Servers and Power Outlets

In the OBWI Target List page, power control actions are selectable for a target with linked outlets. Selecting the Ports - Power Devices tabs, and then clicking on a device name will display the Device Settings, Device Firmware Upgrade, and Outlet List tabs. Click the Outlet List tab to display the outlets linked with a target device.

In the following figure, the target device named Server2 has linked power outlets. Clicking on the drop-down menu arrow in the Action column shows the additional power actions available.

Figure 3.2: Target List

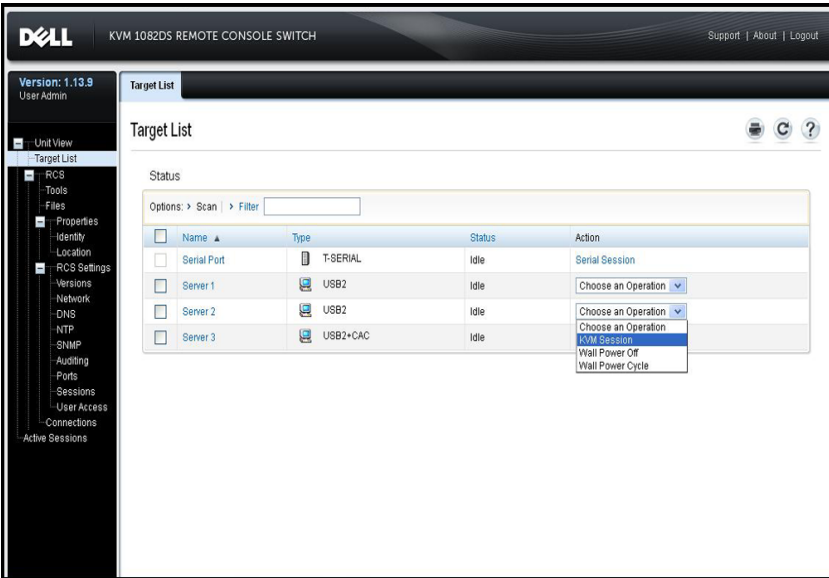

In the following figure, the target Unit Overview page for Server2 shows the Wall Outlet Power, where outlet 1 and outlet 9 from PDU 1 are linked to Server2.

Figure 3.3: Target Overview Server2

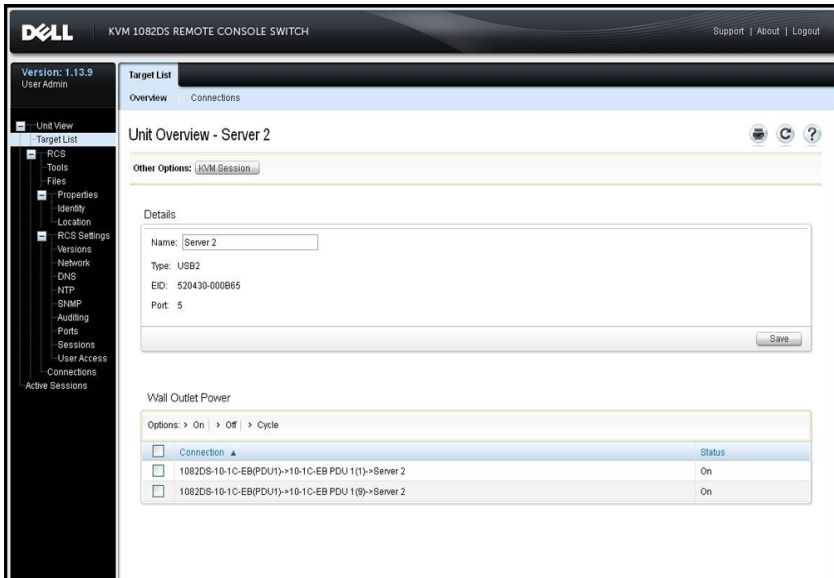

Grouping Power Outlets

The outlets can be linked or associated with the target server for easier control. To group outlets (or outlets to servers), the first device to be named must use the Manual name field. The second and subsequent devices must use the Link to Target Device menu, and then select the target name for the first device from the drop down list.

Power actions performed on the Target List page are applied to all applicable outlets. Power control actions for specific power outlets of a target may be performed on the Unit Overview page. In the following figure, the target named Group2 is composed of power outlets 4 and 5 from PDU 1.

To group sockets 4 and 5:

- 1 Select outlet 4 to display the **Power Devices Outlet Settings** page.
- 2 Select **Manual** and enter Group2.
- 3 Click **Save**.

- 4 Select outlet 5 to display the **Power Devices Outlet Settings** page.
- 5 Select **Link to Target Device**, select **Group2** from the drop down menu.
- 6 Click **Save**. After returning to the Outlet List, outlets 4 and 5 will have the same name.

Figure 3.4: Target Overview for Group2

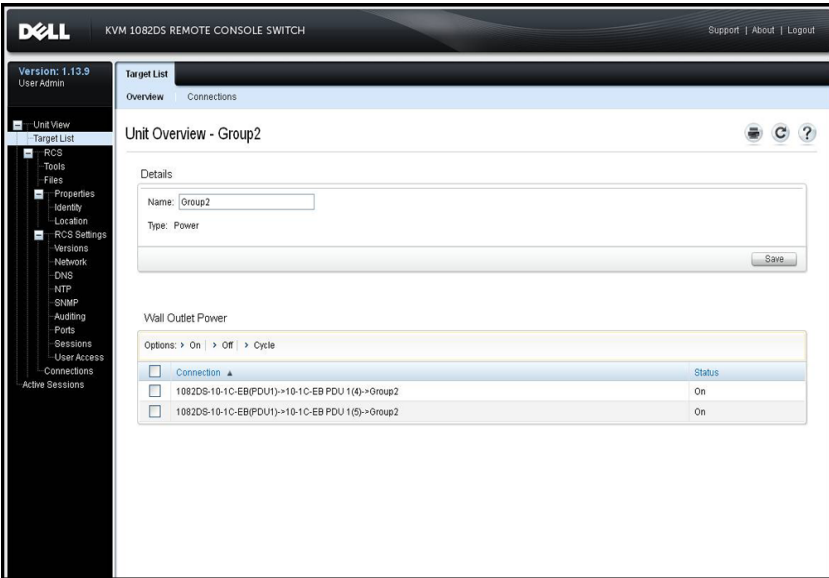

Default Outlet Names

On the Power Devices page, the checkbox “Assign Default Names to Outlets” controls whether or not power outlets are given default names for a power device, as shown in the following figure. Only power outlets with names are listed on the Target page. Default assigned power outlet names may be removed by clearing the "Assign Default Names to Outlets" checkbox and saving. Power outlets without names are assigned default names by turning on “Assign Default Names to Outlets” and saving.

Figure 3.5: RCS Power Devices Page

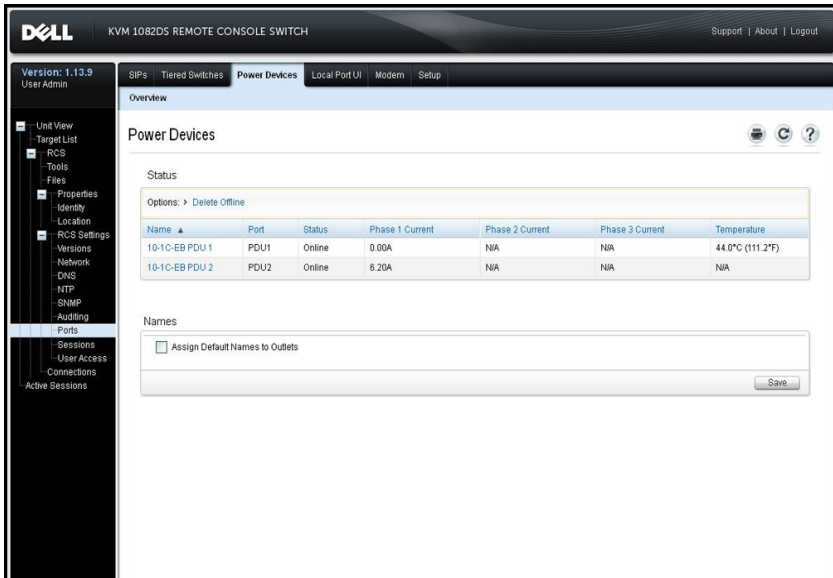

Assigning an Outlet Name

On the Power Device Outlet Settings page, three options are available for assigning the name of a outlet as shown in the following figure. The options are Manual Name assignment, Link to Target Device and Do Not Display as Target Device.

Figure 3.6: Power Device Outlet Settings Page

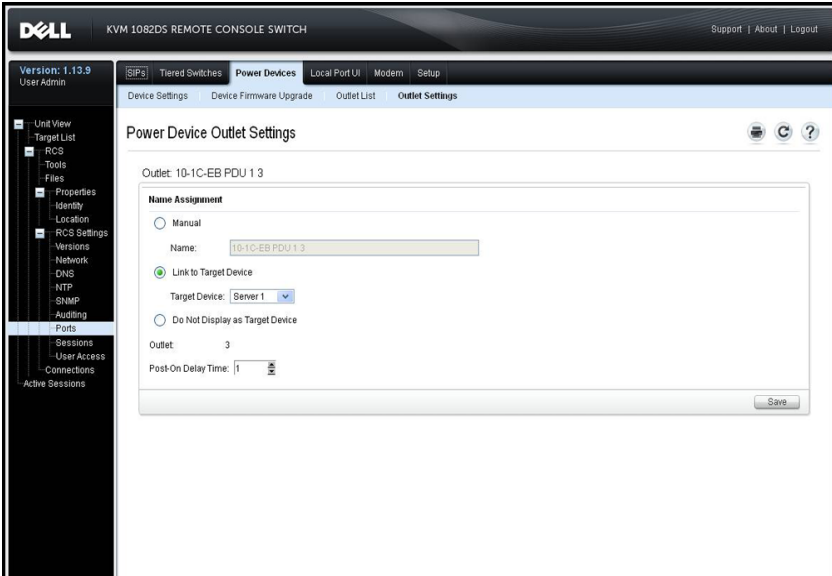

- The Manual Name assignment gives a unique name to an outlet. The name must be unique for all the SIPs and power outlet names. An attempt to specify a manual name which is not unique will result in an error and the name will not be saved.
- The Link to Target List assignment links the outlet to another target name (either an outlet or SIP) for power control of the named target. When an outlet is linked to a SIP target name, typically the outlet physically provides power to the server attached to the SIP.
- The Do Not Display as Target Device option gives the outlet a blank name, which prevents it from being displayed on the Target List page. This option may be used for spare outlets to remove them from the Target List page.

Access Control Inheritance

When a power outlet name is changed by linking it to a target, the outlet inherits the access control already configured for that target name. When a SIP is added, if the name retrieved from the SIP matches the name of an existing

target, the new SIP inherits the access control from that target. When a target device is renamed, all the SIPs and outlets of that target are renamed, and they carry forward the access control previously configured for the old target name.

Renaming of a Target Device

On the Target List - Overview page, the name for that target may be changed to any unique target name. The name must be unique for the set of all targets, including SIPs and power outlets. When a target is renamed, all outlets linked to that target are also given the new target name.

Prioritized Status of Target Devices

On the Target List page, a target with linked power outlets controls multiple devices. The Status value displayed for a target is chosen as the highest priority of all the status values of the devices. The following table shows the possible status values in priority order (highest to lowest) and the applicable target device types.

Table 3.4: Target Status Values

Status Value	Applicable for:		Status Description
	SIP	Power Outlet	
In Use	x	N/A	A session is active
Path Blocked	x	N/A	Path to Target is in use by another session
Upgrading	x	N/A	SIP is being upgraded
Turning On	N/A	x	One or more outlets are turning on
Turning Off	N/A	x	One or more outlets are turning off

Status Value	Applicable for:		Status Description
	SIP	Power Outlet	
No Power	x	N/A	No power detected on SIP
Partial Power	N/A	x	Target has outlets in both on and off states
Locked-Off	N/A	x	One or more outlets are locked on
Turned Off	N/A	x	One or more outlets are turned off
Locked-On	N/A	x	One or more outlets are locked off
Idle	x	N/A	No session active; SIP has power
Turned On	N/A	x	Outlets are turned on

When a target device has multiple power outlets linked by name and they do not have a common power state, the RCS may consider the Locked-Off outlet status as Off, and the Locked-On outlet status as On. The following table lists the resulting Status values for combinations of two outlet status values.

Table 3.5: Multiple Outlet Status Values and Displayed Status

Outlet 1 Status	Outlet 2 Status	Resulting Status
Off	Off	Off
Off	On	Partial Power
On	On	Powered On

Outlet 1 Status	Outlet 2 Status	Resulting Status
Locked-On	On	Powered On
Locked-On	Locked-On	Locked-On
Locked-On	Off	Partial Power
Locked-Off	On	Partial Power
Locked-Off	Locked-Off	Locked-Off
Locked-Off	Off	Powered Off
Locked-On	Locked-Off	Partial Power

Local Session Page on the Local Port

On the local port's Local Session page, when the target of the active session has power outlets linked, three power controls are displayed on the page under the Active session. The following figure illustrates the power controls displayed for an active local port session for a target named Server2.

Figure 3.7: Local Session Page With Power Controls

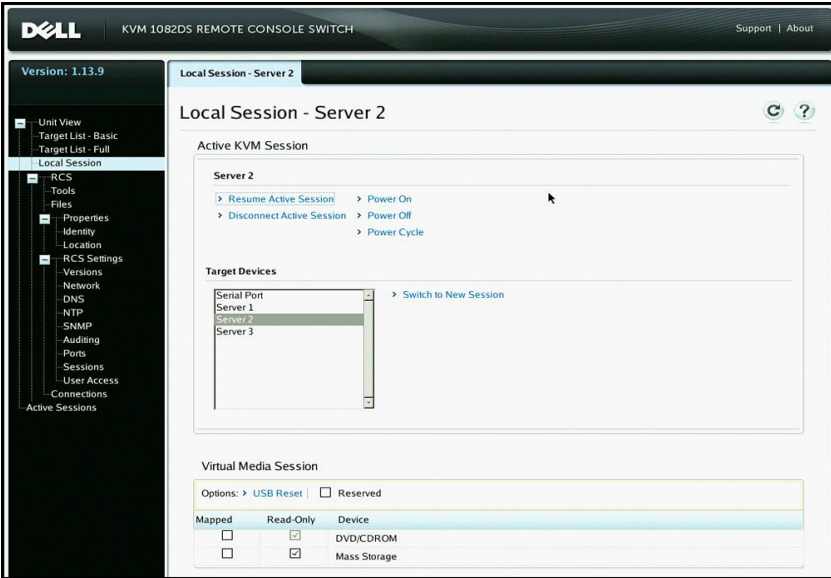

Local Port UI Settings

To change how the local UI is invoked:

- 1 From the side navigation bar, select **Ports - Local Port UI** to open the Local Port UI Settings screen.
- 2 Under the Invoke Local Port UI heading, select the checkbox next to one or more of the listed methods.
- 3 Click **Save**.

You can turn on or turn off local port user interface authentication and choose a user access level. If you turn on local port user interface authentication, you will be required to log in to use the interface.

You can also select the keyboard language for the local port, scan mode time, enable/disable the local port password and select a user preemption level. The

preemption level of users determines whether they may disconnect another user's serial or KVM session with a target device. Preemption levels range from 1 - 4, with 4 being the highest level. For example, a user with a preemption level of 4 may preempt other level 4 users, as well as those with a level 1, 2, or 3 setting.

To change the Local Port User Authentication (Administrator only):

- 1 From the side navigation bar, select **Ports - Local Port UI** to open the Local Port UI Settings screen.
- 2 Select or deselect the **Disable Local Port User Authentication** checkbox.
- 3 If **Disable Local Port User Authentication** is checked, select one of the following options from the User Access Level drop-down menu: **User**, **User Administrator**, or **RCS Administrator**.
- 4 Click **Save**.

Modem Settings

From the RCS Modem Settings screen, you can configure several modem settings, as well as view the following modem settings: Local Address, Remote Address, Subnet Mask, and Gateway.

For information on connecting your switch to a modem, see "Connecting the RCS Hardware" on page 25.

To configure modem settings:

- 1 From the side navigation bar, select **Ports - Modem** to open the Modem Settings screen.
- 2 Either enable or disable the **Modem sessions can preempt digital sessions** checkbox.
- 3 Select an Authentication Timeout time from 30 to 300 seconds, and an Inactivity Timeout time from 1 to 60 minutes.
- 4 Select **Save**.

Setup Settings - Port Security

From the serial setup port, you can change the appliance network configuration, enable debug information, and reset the appliance.

To enable a password to restrict access the serial setup port:

- 1 From the side navigation bar, select **RCS Settings - Ports - Setup** to display the Setup Port Settings page.
- 2 Click to enable the **Enable Setup Port Security** box.
- 3 Enter and confirm your password.
- 4 Click **Save**.

Sessions

From the Active Sessions screen, you can view a list of active sessions and the following information about each session: Target Device, Owner, Remote Host, Duration, and Type.

Configuring General Sessions

To configure general session settings:

- 1 From the side navigation bar, select **Sessions - General**. The General Session Settings screen appears.
- 2 Select or deselect the **Enable Inactivity Timeout** checkbox.
- 3 In the Inactivity Timeout field, enter the amount of inactive time you want to pass before the session closes (from 1 to 90 minutes).
- 4 In the Login Timeout field, enter the amount of inactive time you want to pass before you must log in again (from 21 to 120 seconds).
- 5 Select or deselect the **Enable Preemption Timeout** checkbox.

- 6 In the Preemption Timeout field, enter the amount of time (from 1 to 120 seconds) that a prompt will be displayed to inform you that your session is going to be preempted.
- 7 Select the applicable session sharing options (Enabled, Automatic, Exclusive, or Stealth).
- 8 Select the Input Control Timeout from 1 to 50, with 1 representing one tenth of a second.
- 9 Click Save.

Configuring KVM Sessions

To configure KVM session settings:

- 1 From the side navigation bar, select **Sessions - KVM**. The KVM Session Settings screen appears.
- 2 Select an encryption level for keyboard and mouse signals (**128-bit SSL (ARCFOUR)**, **DES**, **3DES**, or **AES**) and for video signals (**128-bit SSL (ARCFOUR)**, **DES**, **3DES**, **AES**, or **None**).
- 3 Select a language from the Keyboard drop-down menu.
- 4 If your hardware includes the USB2+CAC SIP, select the video resolution.
- 5 Click Save.

Configuring Local Virtual Media Sessions

To set virtual media options:

- 1 From the side navigation bar, select **Sessions - Virtual Media** to open the Virtual Media Session Settings screen.
- 2 Either enable or disable the **Virtual Media locked to KVM Sessions** checkbox.
- 3 Either enable or disable the **Allow Reserved Sessions** checkbox.
- 4 Select one of the following options from the Virtual Media Access Mode from the drop-down menu: **Read-Only** or **Read-Write**.

- 5 Select one of the Encryption Levels that you wish to be supported.
- 6 Click **Save**.
- 7 Select the checkbox next to each SIP for which you want to enable virtual media and click **Enable VM**.

-or-

Select the checkbox next to each SIP for which you want to disable virtual media and click **Disable VM**.

Virtual Media Options

You can determine the behavior of the switch during a virtual media session using the options provided in the Virtual Media Session Settings screen. Table 3.4 outlines the options that can be set for virtual media sessions.

For information about using virtual media in a KVM session, see "Virtual Media" on page 96.

Table 3.6: Virtual Media Session Settings

Setting	Description
Session Settings: Virtual Media locked to KVM Session	The locking option specifies whether a virtual media session is locked to the KVM session on the target device. When locking is enabled (default) and the KVM session is closed, the virtual media session will also be closed. When locking is disabled and the KVM session is closed, the virtual media session will remain active.

Setting	Description
Session Settings: Allow Reserved Sessions	<p>Ensures that a virtual media connection can only be accessed with your username and that no other user can create a KVM connection to that target device. When the associated KVM session is disconnected, the virtual media session may be disconnected according to the Locked setting in the Virtual Media dialog box.</p>
Drive Mappings: Virtual Media Access Mode	<p>You may set the access mode for mapped drives to read-only or read-write. When the access mode is read-only, the user will not be able to write data to the mapped drive on the client server. When the access mode is read-write, the user will be able to read and write data from/to the mapped drive. If the mapped drive is read-only by design (for example, a CD-ROM drive, DVD-ROM drive or ISO images), the configured read-write access mode will be ignored. Setting the read-only mode can be helpful when a read-write drive such as a mass storage device or a USB removable media is mapped, and you wish to prevent the user from writing data to it.</p> <p>You can have one DVD drive and one mass storage device mapped concurrently. A CD drive, DVD drive, or ISO disk image file is mapped as a virtual CD/DVD drive.</p>
Encryption Level	<p>You may configure encryption levels for virtual media sessions. The choices are: None (default), 128-bit SSL (ARCFOUR), DES, 3DES, and AES.</p>

Setting	Description
Virtual Media Access per SIP:Enable VM/Disable VM	The Virtual Media Access per the SIP section lists all virtual media SIPs. The list includes details about each cable, including the option to enable or disable virtual media for each cable.

Local Users

Local users can also determine the behavior of virtual media from the Local Session screen. In addition to connecting and disconnecting a virtual media session, you can configure the settings in the following table.

Table 3.7: Local Virtual Media Session Settings

Setting	Description
CD ROM/ DVD ROM	Allows virtual media sessions to the first detected CD-ROM or DVD-ROM (read-only) drives. Enable this checkbox to establish a virtual media CD-ROM or DVD-ROM connection to a target device. Disable to end a virtual media CD-ROM or DVD-ROM connection to a target device.
Mass Storage	Allows virtual media sessions to the first detected mass storage drive. Enable this checkbox to establish a virtual media mass storage connection to a target device. Disable to end a virtual media mass storage connection to a target device.
Reserved	Ensures that a virtual media connection can only be accessed with your username and that no other user can create a KVM connection to that target device.

Configuring Serial Sessions

To configure serial session settings:

- 1 From the side navigation bar, click **Sessions - Serial** to display the Serial Session Settings screen.
- 2 Either enable or disable the **Telnet Access Enabled** checkbox.
- 3 Click **Save**.

Setting Up User Accounts

Managing Local Accounts

The switch OBWI provides local and login security through administrator-defined user accounts. By selecting **User Accounts** on the side navigation bar, administrators may add and delete users, define user preemption, and access levels and change passwords.

Access Levels

When a user account is added, the user may be assigned to any of the following access levels: RCS Administrators, User Administrators, and Users.

Table 3.8: Allowed Operations by Access Level

Operation	RCS Administrator	User Administrator	Users
Configure interface system-level settings	Yes	No	No
Configure access rights	Yes	Yes	No
Add, change and delete user accounts	Yes, for all access levels	Yes, for Users and User Administrators only	No

Operation	RCS Administrator	User Administrator	Users
Change your own password	Yes	Yes	Yes
Access target device	Yes, all target devices	Yes, all target devices	Yes, if allowed

To add a new user account (User Administrator or RCS Administrator only):

- 1 On the side navigation bar, select **User Accounts - Local User Accounts** to open the Local User Accounts screen.
- 2 Click the **Add** button.
- 3 Enter the name and password of the new user in the blanks provided.
- 4 Select the access level for the new user.
- 5 Select any of the available target devices that you wish to assign to the user account and click **Add**.



NOTE: User Administrators and RCS Administrators can access all target devices.

- 6 Click **Save**.

To delete a user account (User Administrator or RCS Administrator only):

- 1 On the side navigation bar, select **User Accounts - Local Accounts** to open the Local User Accounts screen.
- 2 Click the checkbox to the left of each account that you wish to delete, then click **Delete**.

To edit a user account (Administrator or active user only):

- 1 On the side navigation bar, select **User Accounts - Local Accounts**. The Local User Accounts screen is displayed.
- 2 Click the name of the user you wish to edit. The user profile will appear.

- 3 Fill out the user information on the screen, then click **Save**.

Avocent Management Software Device IP Addresses

You can contact and register an unmanaged switch with an Avocent management software server by specifying the IP address of the management software server.

To configure the server IP address:

- 1 On the side navigation bar, select **User Accounts - Avocent**. The Avocent Management Software Settings screen is displayed.
- 2 Enter the server IP addresses that you want to contact. Up to four addresses are allowed.
- 3 Use the scroll bar to select the desired retry interval.
- 4 To disassociate an RCS that has been registered with the server, click the **Disassociate** button.
- 5 Click **Save**.

LDAP

The Dell 1082DS/2162DS/4322D RCS can authenticate and authorize users via a local database or by an external scalable distributed directory service using the Dell RCS software or OBWI with LDAP (Lightweight Directory Assistance Protocol) support. Refer to the LDAP section for additional information on configuring and using LDAP on the RCS.

Override Admin

Should a network failure occur, an account is provided that may be used regardless of the unit's ability to authenticate against an LDAP server. Refer to Configure the Override Admin Account in Chapter 5.

Active Sessions

From the Active Sessions screen, you can view a list of active sessions and the following information about each session: Target Device, Owner, Remote Host, Duration, and Type.

Closing a Session

To close a session:

- 1 From the side navigation bar, select **Active Sessions** to display the RCS Active Sessions screen.
- 2 Click the checkbox next to the desired target device(s).
- 3 Click **Disconnect**.



NOTE: If there is an associated locked virtual media session, it will be disconnected.

To close a session (local users only):

- 1 From the side navigation bar, select **Local Session**.
- 2 Select the **Disconnect Active Session** checkbox.

The Video Viewer Window

The Video Viewer is used to conduct a KVM session with the target devices attached to a switch using the OBWI. When you connect to a device using the Video Viewer, the target device desktop appears in a separate window containing both the local and the target device cursors.

The switch OBWI software uses a Java-based program to display the Video Viewer window. The switch OBWI automatically downloads and installs the Video Viewer the first time it is opened.



NOTE: Java 1.6.0_11 or later is required to launch a session.



NOTE: The switch OBWI does not install the Java Resource Engine (JRE). The JRE is available as a free download from <http://www.sun.com>.



NOTE: The switch OBWI uses system memory to store and display images within Video Viewer windows. Each opened Video Viewer window requires additional system memory. An 8-bit color setting on the client server requires 1.4 MB of memory per Video Viewer window, a 16-bit color setting requires 2.4 MB and a 32-bit color setting requires 6.8 MB. If you attempt to open more Video Viewer windows than your system memory allows (usually four), you will receive an out-of-memory error and the requested Video Viewer window will not open.

If the device you are attempting to access is currently being viewed by another user, you will be prompted to preempt the other user if your preemption level is equal to or greater than the other user's preemption level. An RCS Administrator can also disconnect an active user via the Active Session page. For more information, see "Active Sessions" on page 80.

Figure 4.1: Video Viewer Window (normal window mode)

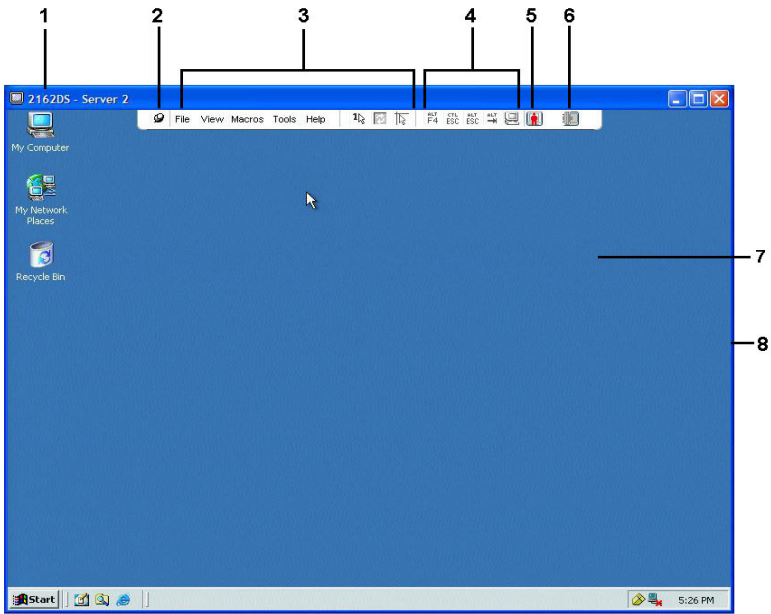

Table 4.1: Video Viewer Descriptions

Number	Description
1	Title Bar: Displays the name of the target device being viewed. When in Full Screen mode, the title bar disappears and the target device name appears between the menu and toolbar.
2	Thumbtack icon: Locks the display of the menu and toolbar so that it is visible at all times.

Number	Description
3	Menu and toolbar: Enables you to access many of the features in the Video Viewer window. The menu and toolbar is in a show/hide state if the thumbtack has not been used. Place your cursor over the toolbar to display the menu and toolbar. Up to ten commands and/or macro group buttons can be displayed on the toolbar. By default, the Single Cursor Mode, Refresh, Automatic Video Adjust and Align Local Cursor buttons appear on the toolbar. For more information, see "Changing the Toolbar" on page 83 and "Macros" on page 104.
4	Macro buttons: Commonly used keyboard sequences that can be sent to the target device.
5	Connection Status Indicator: Indicates the status of the user that is connected to the RCS for this server. The modes are exclusive, basic active connection, primary active sharing, secondary active sharing, passive sharing, stealth, and scanning.
6	Smart Card Status Indicators: Indicate whether or not a smart card is in the smart card reader. The Video Viewer screen smart card icon is greyed out and indicates that the smart card option is unavailable or disabled. The icon is green if the smart card is mapped.
7	Display area: Accesses the server desktop.
8	Frame: Resizes the Video Viewer window by clicking and holding on the frame.

Changing the Toolbar

You can choose the amount of elapsed time before the toolbar hides in the Video Viewer window when it is in show/hide state (that is, not locked in place by the thumbtack).

To specify a toolbar hide time:

- 1 Select **Tools - Session Options** from the Video Viewer window menu.

-or-

Click the **Session Options** button.

The Session Options dialog box appears.

- 2 Click the **Toolbar** tab.
- 3 Use the arrow keys to specify the number of elapsed seconds prior to hiding the toolbar.
- 4 Click **OK** to save your changes and close the dialog box.

Launching a Session



NOTE: When using a non-proxied connection, video performance over a slower network connection may be less than optimal. Since certain color settings (such as Grayscale) use less network bandwidth than others (such as Best Color), changing the color settings can increase video performance. For optimal video performance over a slower network connection, use a color setting such as Grayscale/Best Compression or Low Color/High Compression. See "Adjusting the View" on page 85 for more information.



NOTE: If a user connects to a target device with a higher screen resolution than the local computer, the Video Viewer window will display a portion of the target device screen, with scroll bars for viewing the remainder of the screen. The user may view the entire screen by adjusting the resolution on the target device, the local computer or both.

To launch a KVM session from the switch Explorer window:

- 1 Click on a device listed on the Target List screen to open the unit overview window.
- 2 Click the **KVM Session** link to open the Video Viewer in a new window.

Session Time-out

A remote session can time-out when no activity occurs in a Session window for a specified time. The session time-out value can be configured in the RCS KVM Session Settings window. The specified time-out value will be used the next time the switch OBWI is accessed.

To enable, disable, or configure the session time-out:

- 1 In the side menu, select **Unit View - RCS - RCS Settings - Sessions - General**.
- 2 Select the desired setting for the **Enable Activity Timeout** box.
- 3 If necessary, select the time limit for the inactivity time-out.
- 4 Click **Save**.

Window Size



NOTE: The **View - Scaling** command is not available if the Video Viewer window is in Full Screen mode or to non-primary users of a shared session.

When the switch OBWI is used for the first time, any open Video Viewer windows display at a resolution of 1024 x 768 until the user changes the value. Each Video Viewer window can be set to a different resolution.

The switch OBWI automatically adjusts the display if the window size changes during a session as long as autoscaling is enabled. If the target device resolution changes any time during a session, the display adjusts automatically.

To change the Video Viewer window resolution:

- 1 Select the **View - Scaling** command.
- 2 Select the desired resolution.

Adjusting the View

Using menus or task buttons in the Video Viewer window, you can do the following:

- Align the mouse cursors.
- Refresh the screen.

- Enable or disable Full Screen mode. When Full Screen mode is enabled, the image adjusts to fit the desktop up to a size of 1600 x 1200 or 1680 x 1050 (widescreen). If the desktop has a higher resolution, the following occurs:
 - The full-screen image is centered in the desktop, and the areas surrounding the Video Viewer window are black.
 - The menu and toolbar are locked so that they are visible at all times.
- Enable automatic, full or manual scaling of the session image:
 - With full scaling, the desktop window remains fixed and the device image scales to fit the window.
 - With automatic scaling, the desktop window is sized to match the resolution of the target device being viewed.
 - With manual scaling, a drop-down menu of supported image scaling resolutions is displayed.
- Change the color depth of the session image.

To align the mouse cursors:

Click the **Align Local Cursor** button in the Video Viewer window toolbar. The local cursor should align with the cursor on the remote device.



NOTE: If cursors drift out of alignment, turn off mouse acceleration in the attached device.

To refresh the screen, click the **Refresh Image** button in the Video Viewer window, or select **View - Refresh** from the Video Viewer window menu. The digitized video image is completely regenerated.

To enable Full Screen mode, click the **Maximize** button, or select **View - Full Screen** from the Video Viewer window menu. The desktop window disappears and only the accessed device desktop is visible. The screen resizes up to a maximum of 1600 x 1200 or 1680 x 1050 (widescreen). If the desktop has a higher resolution, then a black background surrounds the full screen image. The floating toolbar appears.

To disable Full Screen mode, click the **Full Screen Mode** button on the floating toolbar to return to the desktop window.

To enable full scaling, select **View - Scaling** from the Video Viewer window menu and select **Full Scale**. The device image scales automatically to the resolution of the target device being viewed.

To enable manual scaling, select **View - Scaling** from the Video Viewer window menu. Choose the dimension to scale the window. The available manual scaling sizes will vary according to your system.

Refreshing the Image

Clicking the **Refresh Image** button in the Manual Video Adjust dialog box completely regenerates the digitized video image.



NOTE: You can also select **View - Refresh** from the Video Viewer window menu to refresh the image.

Video Settings

Additional Video Adjustment

Generally, the Video Viewer window automatic adjustment features optimize the video for the best possible view. However, users can fine-tune the video with the help of Dell Technical Support by selecting the **Tools - Manual Video Adjust** command in the Video Viewer window menu or clicking the **Manual Video Adjust** button. This displays the Manual Video Adjust dialog box. Video adjustment is a per target setting.

Users can also verify the level of packets per second required to support a static screen by observing the packet rate located in the lower left-hand corner of the dialog box.

To manually adjust the video quality of the window:



NOTE: The following video adjustments should be made only with the help of Dell Technical Support.

1 Select **Tools - Manual Video Adjust** from the Video Viewer window menu.

-or-

Click the **Manual Video Adjust** button.

The Manual Video Adjust dialog box appears.

Figure 4.2: Manual Video Adjust Dialog Box

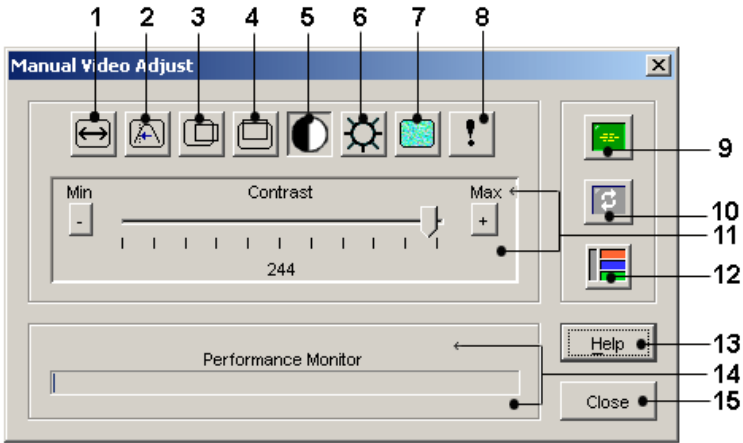

Table 4.2: Descriptions for Figure 4.2

Number	Description	Number	Description
1	Image Capture Width	9	Automatic Video Adjustment
2	Pixel Sampling/Fine Adjust	10	Refresh Image
3	Image Capture Horizontal Position	11	Adjustment bar

Number	Description	Number	Description
4	Image Capture Vertical Position	12	Video Test Pattern
5	Contrast	13	Help
6	Brightness	14	Performance Monitor
7	Noise Threshold	15	Close button
8	Priority Threshold		

- 2 Click the icon corresponding to the feature you wish to adjust.
- 3 Move the Contrast slider bar and then fine-tune the setting by clicking the **Min (-)** or **Max (+)** buttons to adjust the parameter for each icon pressed. The adjustments display immediately in the Video Viewer window.
- 4 When finished, click **Close** to exit the Manual Video Adjust dialog box.

Target Video Settings

The Image Capture Width, Pixel Sampling/Fine Adjust, Image Capture Horizontal Position and Image Capture Vertical Position adjustments affect how the target video is captured and digitized. They are seldom changed.

The image capture parameters are automatically changed by the Automatic Adjustment function. A special image is required on the target in order to make accurate adjustments independently.

Automatic Video Adjustment

In most cases, you do not need to alter the Video Settings from the default settings. The system automatically adjusts and uses the optimal video parameters. The switch OBWI performs best when the video parameters are set such that no (0) video packets are transmitted for a static screen.

You can easily adjust your video parameters to ideal settings by clicking on the **Auto Adjust Video** button in the Manual Video Adjust dialog box.



NOTE: You can also select **Tools - Automatic Video Adjust** from the Video Viewer window menu or click the **Automatic Video Adjust** toolbar icon to automatically adjust the video.

Video Test Pattern

Clicking the **Video Test Pattern** button in the Manual Video Adjust dialog box toggles a display of a video test pattern. Click the **Video Test Pattern** button again to toggle back to a normal video image.

Vendor-specific Video Settings

Video settings vary significantly among manufacturers. Dell maintains an online database of optimized video settings for various video cards, particularly Sun-specific ones. This information can be obtained from the Dell online knowledge base or by calling Dell technical support.

Color Settings

Adjusting Color Depth

The Dambrackas Video Compression® (DVC) algorithm enables users to adjust the number of viewable colors in a remote session window. You can choose to display more colors for the best fidelity or fewer colors to reduce the volume of data transferred on the network.

Video Viewer windows can be viewed using the Best Color Available (slower updates), Best Compression (fastest updates), a combination of Best Color and Best Compression or in Grayscale.

You can specify the color depths of individual ports and channels by selecting the **View Color** command in a remote session window. These settings are saved individually per channel.

Contrast and Brightness

If the image in the Video Viewer window is too dark or too light, select **Tools - Automatic Video Adjust** or click the **Automatic Video Adjust** button. This command is also available in the Video Adjustments dialog box. In most cases, this corrects video issues.

When clicking **Auto Adjust** several times does not set the contrast and brightness as desired, adjusting the contrast and brightness manually can help. Increase the brightness. Do not go more than 10 increments before moving the contrast. Generally, the contrast should be moved very little.

Noise Settings

Detection Thresholds

In some cases, noise in the video transmission keeps the packets/sec count up, which is indicated by small dots changing in the area of the cursor when it is moved. Varying the threshold values may result in “quieter” screens and can improve cursor tracking.

You can modify Noise Threshold and Priority Threshold values if you are using standard video compression. You can restore default threshold values by clicking **Auto Adjust Video**.



NOTE: Leaving the noise threshold at zero triggers constant video refresh, resulting in high network usage and a flickering video. It is recommended that the noise threshold be set at the highest level that allows efficient system performance, while still being able to recover pixel colors that the mouse cursor travels over.



NOTE: When adjusting the noise threshold, the slider bar is used for large adjustments and the Plus (+) and Minus (-) buttons at either end of the slider bar are used for fine-tuning.

See "Adjusting the View" on page 85 for information about changing the color depth.

Mouse Settings

Adjusting Mouse Options

The Video Viewer window mouse options affect cursor type, Cursor mode, scaling, alignment and resetting. Mouse settings are device-specific; that is, they may be set differently for each device.



NOTE: If the device does not support the ability to disconnect and reconnect the mouse (almost all newer PCs do), then the mouse will become disabled and the device will have to be rebooted.

Cursor Type

The Video Viewer window offers five appearance choices for the local mouse cursor. You can also choose no cursor or the default cursor.

In Single Cursor mode, the display of the local (second) cursor in the Video Viewer window turns off and only the target device mouse pointer is visible. The only mouse movements that appear are those of the target device remote cursor. Use Single Cursor mode when there is no need for a local cursor.

Figure 4.3: Video Viewer Window With Local and Remote Cursors Displayed

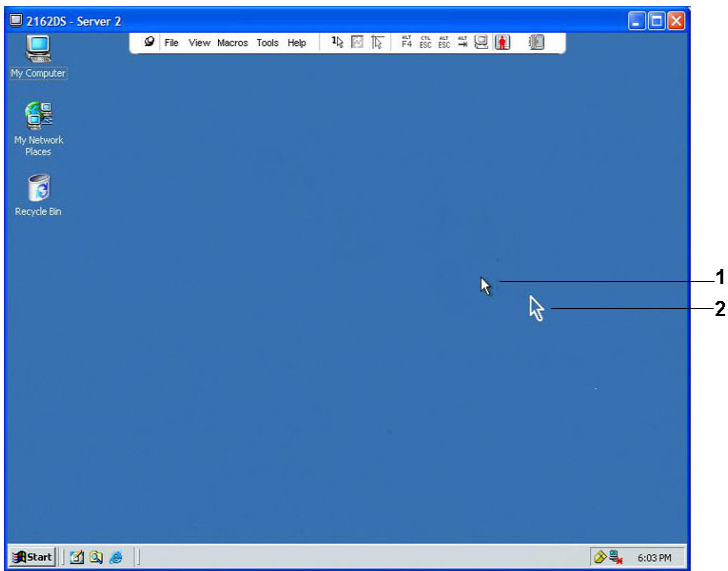



Table 4.3: Descriptions for Figure 4.3

Number	Description
1	Remote Cursor
2	Local Cursor

The Cursor mode status of the Video Viewer window displays in the title bar, including the keystroke that will exit Single Cursor mode. You can define the keystroke that will exit Single Cursor mode in the Session Options dialog box.

 **NOTE:** When using a device that captures keystrokes before they reach the client server, you should avoid using those keys to restore the mouse pointer.

To enter Single Cursor mode, select **Tools - Single Cursor Mode** from the Video Viewer window menu, or click the **Single Cursor Mode** button. The local cursor does not appear and all movements are relative to the target device.

To select a key for exiting Single Cursor mode:

- 1 Select **Tools - Session Options** from the Video Viewer window menu.
-or-
Click the **Session Options** button.
The Session Options dialog box appears.
- 2 Click the **Mouse** tab.
- 3 Select a terminating keystroke from the drop-down menu in the Single Cursor mode area.
- 4 Click **Save** to save settings.

When you enable Single Cursor mode, you can press the specified key to return to Regular Desktop mode.

To exit Single Cursor mode, press the key on the keyboard that is identified in the title bar.

To change the mouse cursor setting:

- 1 Select **Tools - Session Options** from the Video Viewer window menu.
-or-
Click the **Session Options** button.
The Session Options dialog box appears.
- 2 Click the **Mouse** tab.
- 3 Select a mouse cursor type in the Local Cursor panel.
- 4 Click **OK** to save settings.

Mouse Scaling

Some earlier versions of Linux did not support adjustable mouse accelerations. For installations that must support these earlier versions, you can choose among three pre-configured mouse scaling options or set your own custom scaling. The pre-configured settings are Default (1:1), High (2:1) or Low (1:2):

- In a 1:1 scaling ratio, every mouse movement on the desktop window sends an equivalent mouse movement to the target device.
- In a 2:1 scaling ratio, the same mouse movement sends a 2X mouse movement.
- In a 1:2 scaling ratio, the value is 1/2X.

To set mouse scaling:

- 1 Select **Tools - Session Options** from the Video Viewer window menu.

-or-

Click the **Session Options** button.

The Session Options dialog box appears.

- 2 Click the **Mouse** tab.
- 3 To use one of the pre-configured settings, check the appropriate radio button.

-or-

To set custom scaling:

- a. Click the **Custom** radio button to enable the X and Y fields.
- b. Type a scaling value in the X and Y fields. For every mouse input, the mouse movements are multiplied by the respective X and Y scaling factors. Valid input range is 0.25-3.00.

Mouse Alignment and Synchronization

Because the switch OBWI cannot get constant feedback from the mouse, there are times when the mouse on the switch may lose sync with the mouse on the

host system. If your mouse or keyboard no longer responds properly, you can align the mouse to reestablish proper tracking.

Alignment causes the local cursor to align with the remote target device's cursor. Resetting causes a simulation of a mouse and keyboard reconnect as if you had disconnected and reconnected them.

To realign the mouse, click the **Align Local Cursor** button in the Video Viewer window toolbar.

Virtual Media

The virtual media feature allows the user on the client server to map a physical drive on that machine as a virtual drive on a target device. The client server may also add and map an ISO or floppy image file as a virtual drive on the target device. You may have one CD drive and one mass storage device mapped concurrently.

- A CD/DVD drive, disk image file (such as an ISO or floppy image file) is mapped as a virtual CD/DVD-ROM drive.
- A floppy drive, USB memory device or other media type is mapped as a virtual mass storage device.

For information on configuring virtual media settings using the OBWI, see "Configuring Local Virtual Media Sessions" on page 73.

Requirements

The target device must support virtual media and be connected to the KVM switch with a USB2 or USB2+CAC SIP.

The target device must be intrinsically able to use the types of USB2-compatible media that you virtually map. In other words, if the target device does not support a portable USB memory device, you cannot map that on the client server as a virtual media drive on the target device.

The user (or user group to which the user belongs) must have permission to establish virtual media sessions and/or reserved virtual media sessions to the target device. See "Setting Up User Accounts" on page 77.

Only one virtual media session may be active to a target device at one time.

Sharing and Preemption Considerations

The KVM and virtual media sessions are separate; therefore, there are many options for sharing, reserving or preempting sessions. The Avocent management software has the flexibility to accommodate the system needs.

For example, the KVM and virtual media sessions may be locked together. In this mode, when a KVM session is disconnected, so is the associated virtual media session. If the sessions are not locked together, the KVM session can be closed but the virtual media session will remain active. This could be desirable if a user is performing a time-intensive task using the virtual media session (such as an operating system load), and wants to establish a KVM session with a different target device to perform other functions while the operating system load progresses.

Once a target device has an active virtual media session without an associated active KVM session, two situations can occur - the original user (User A) can reconnect or a different user (User B) can connect to that channel. You may set an option in the Virtual Media dialog box (Reserved) that allows only the User A to access that channel with a KVM session.

If User B is allowed to access that session (the Reserved option is not enabled), User B could control the media that is being used in the virtual media session. By using the Reserved option in a tiered environment, only User A could access the lower switch and the KVM channel between the upper switch and lower switch would be reserved for User A.

Virtual Media Dialog Box

The Virtual Media dialog box allows you to manage the mapping and unmapping of virtual media. The dialog box displays all the physical drives on

the client server that can be mapped as virtual drives. You may also add ISO and floppy image files and then map them using the Virtual Media dialog box.

After a device is mapped, the Virtual Media dialog box Details View displays information about the amount of data transferred and the time elapsed since the device was mapped.

You may specify that the virtual media session is reserved. When a session is reserved, and the associated KVM session is closed, another user cannot launch a KVM session to that target device. If a session is not reserved, another KVM session may be launched.

You may also reset the SIP from the Virtual Media dialog box. This action will reset every form of USB media on the target device. It should be used with caution and only when the target device is not responding.

Opening a Virtual Media Session

To launch a virtual media session:

Select **Tools - Virtual Media** from the Video Viewer menu. The Virtual Media dialog box will appear. To make this a reserved session, click **Details**, then select the **Reserved** checkbox.

Figure 4.4: Video Viewer Virtual Media Dialog Box

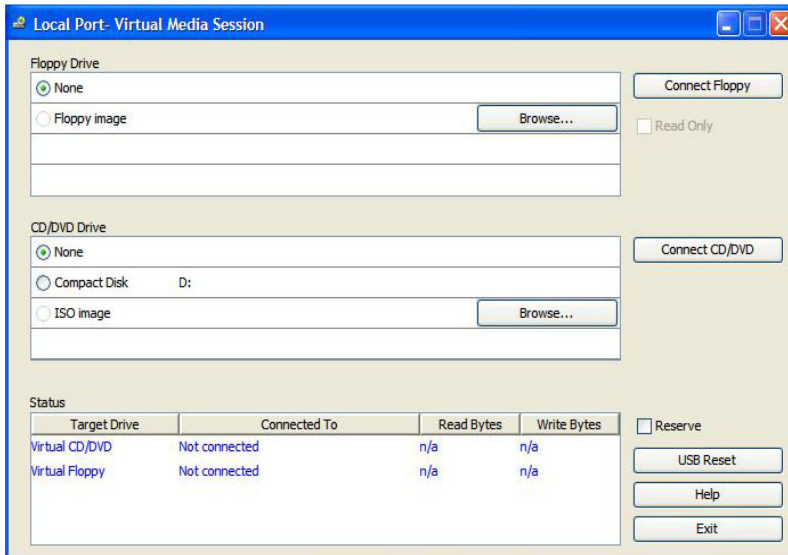

To map a virtual media drive:

- 1 Open a virtual media session from the Video Viewer menu by selecting **Tools - Virtual Media**.
- 2 To map a physical drive as a virtual media drive:
 - a. In the Virtual Media dialog box, click the **Mapped** checkbox next to the drive(s) you wish to map.
 - b. If you wish to limit the mapped drive to read-only access, click the **Read Only** checkbox next to the drive. If the virtual media session settings were previously configured so that all mapped drives must be read only, this checkbox will already be enabled and cannot be changed.

You might wish to enable the **Read Only** checkbox if the session settings enabled read and write access, but you wished to limit a particular drive's access to read only.
- 3 To add and map an ISO or floppy image as a virtual media drive:

- a. In the Virtual Media dialog box, click **Add Image**.
- b. The common file dialog box will appear, with the directory containing disk image files (that is, those ending in .iso or .img) displayed. Select the desired ISO or floppy image file and click **Open**.

-or-

If the client server's operating system supports drag-and-drop, select the desired ISO or floppy image file from the common file dialog box, and drag it onto the Virtual Media dialog box.

- c. The file's header is checked to ensure it is correct. If it is, the common file dialog box will close and the chosen image file will appear in the Virtual Media dialog box, where it can be mapped by clicking the **Mapped** checkbox.
- d. Repeat steps a through c for any additional ISO or floppy images you wish to add. You may add any number of image files (up to the limits imposed by memory), but you may only have one virtual CD or DVD or virtual mass storage mapped concurrently.

If you attempt to map too many drives (one CD or DVD and one mass storage device) or too many drives of a particular type (more than one CD or DVD or mass storage device), a message will be displayed. If you still wish to map a new drive, you must first unmap an existing mapped drive, then map the new drive.

After a physical drive or image is mapped, it may be used on the target device.

To unmap a virtual media drive:

- 1 In the Virtual Media dialog box, uncheck the **Mapped** checkbox next to the drive you wish to unmap.
- 2 You will be prompted to confirm. Confirm or cancel the unmapping.
- 3 Repeat for any additional virtual media drives you wish to unmap.

To display virtual media drive details:

In the Virtual Media dialog box, click **Details**. The dialog box expands to display the Details table. Each row indicates:

- Target Drive - Name used for the mapped drive, such as Virtual CD 1 or Virtual CD 2.
- Mapped to - Identical to Drive information that appears in the Client View Drive column.
- Read Bytes and Write Bytes - Amount of data transferred since the mapping.
- Duration - Elapsed time since the drive was mapped.

To close the Details view, click **Details** again.

To reset all USB devices on the target device:

 **NOTE:** The USB reset feature resets every USB device on the target device, including the mouse and keyboard. It should only be used when the target device is not responding.

- 1 In the Virtual Media dialog box, click **Details**.
- 2 The Details View will appear. Click **USB Reset**.
- 3 A warning message will appear, indicating the possible effects of the reset. Confirm or cancel the reset.
- 4 To close the Details view, click **Details** again.

Closing a Virtual Media Session

To close the Virtual Media dialog box:

- 1 Click **Exit**.
- 2 If you have any mapped drives, a message is displayed, indicating that the drives will be unmapped. Confirm or cancel the operation.

If a user attempts to disconnect a virtual media session or an active KVM session that has an associated locked virtual media session, a confirmation message is displayed, indicating that any virtual media mappings will be lost.



Smart Cards

You can connect a smart card reader to an available USB port on the client server and access attached target devices on the switch system. You can then launch a KVM session to open the Video Viewer and map a smart card.

 **NOTE:** For all smart card readers, you must use a Dell USB2+CAC SIP or an Avocent VMC IQ module.

The smart card status is indicated by the smart card icon at the far right of the Video Viewer toolbar. The following table describes the smart card status icons.

Table 4.4: Smart Card Icons

Icon	Description
	A smart card is not in the smart card reader, or a smart card reader is not attached.
	A smart card is in the smart card reader but has not been mapped yet.
	A smart card is mapped (green icon).

To map a smart card:

- 1 Open a KVM session to display the Video Viewer window menu.
- 2 Insert a smart card into the smart card reader attached to your client server.
- 3 Click **Tools - Map Smart Card** on the Video Viewer window menu.
- 4 If no smart card is mapped to the target device, the **No Card Mapped** option will have a dot beside it. Select your smart card, listed below this option, to map the smart card.

To unmap a smart card, close out the KVM session by clicking **X** in the Video Viewer window menu, selecting **Tools - No Card Mapped**, and either removing

the smart card from the smart card reader or disconnecting the smart card reader from the client server.

Keyboard Pass-through

Keystrokes that a user enters when using a Video Viewer window may be interpreted in two ways, depending on the Screen mode of the Video Viewer window.

- If a Video Viewer window is in Full Screen mode, all keystrokes and keyboard combinations except **Ctrl-Alt-Del** are sent to the remote target device being viewed.
- If a Video Viewer window is in Regular Desktop mode, Keyboard Pass-through mode can be used to control whether the remote target device or local computer recognizes certain keystrokes or keystroke combinations.

Keyboard pass-through must be specified using the Session Options dialog box. When enabled, keyboard pass-through sends all keystrokes and keystroke combinations except **Ctrl-Alt-Del** to the remote target device being viewed when the Video Viewer window is active. When the local desktop is active, keystrokes and keystroke combinations entered by the user affect the local computer.



NOTE: The Ctrl-Alt-Del keyboard combination can be sent only to a remote target device by using a macro.



NOTE: The Japanese keyboard ALT-Han/Zen keystroke combination is always sent to a remote target device regardless of the Screen mode or keyboard pass-through setting.

To specify keyboard pass-through:

- 1 Select **Tools - Session Options** from the Video Viewer window menu.

-or-

Click the **Session Options** button.

The Session Options dialog box appears.

- 2 Click the **General** tab.

- 3 Select **Pass-through all keystrokes in regular window mode**.
- 4 Click **OK** to save setting.

Macros

The switch OBWI comes pre-configured with macros for the Windows, Linux, and Sun platforms.

To send a macro, select **Macros - <desired macro>** from the Video Viewer window menu, or select the desired macro from the buttons available on the Video Viewer menu.

Saving the View

You can save the display of a Video Viewer either to a file or to the clipboard for pasting into a word processor or other program.

To capture the Video Viewer window to a file:

- 1 Select **File - Capture to File** from the Video Viewer window menu.
-or-
Click the **Capture to File** button.
The Save As dialog box appears.
- 2 Enter a filename and choose a location to save the file.
- 3 Click **Save** to save the display to a file.

To capture the Video Viewer window to your clipboard, select **File - Capture to Clipboard** from the Video Viewer window menu, or click the **Capture to Clipboard** button. The image data is saved to the clipboard.

Closing a Session

To close a Video Viewer window session:

Select **File - Exit** from the Video Viewer window.

LDAP Feature for the RCS

LDAP is a protocol standard used for accessing and updating a directory using TCP/IP. The Dell RCS software and OBWI supports both standard and Dell extended schema, and offers strong security features including authentication, privacy, and integrity.



NOTE: Windows 2008 Server is required to use LDAP in IPv6 mode.



NOTE: Use of Microsoft Active Directory to recognize RCS users is supported on the Microsoft Windows® 2000 and Windows Server 2003 operating systems.

The Structure of Active Directory

An Active Directory (AD) deployment consists of a distributed database containing hierarchical structures of objects. Each object is associated with an object class that determines what kinds of data can be stored in that object. The hierarchical structures begin with objects that represent AD domains, deployed to form a hierarchy of domain names that can be represented in a tree diagram the same way DNS name spaces are usually depicted. Dell RCSs are designed to support a single tree of domains that are deployed in either a shallow or deep hierarchical name structure.

Domain Controller Computers

Associated with the Domain hierarchy is the corresponding hierarchy of Domain Controller computers where AD provides LDAP services. Each domain may have multiple peer Domain Controllers and may also be distributed across geographical sites. The suite of Dell RCSs is designed to support both of these

aspects of AD. DNS is used to determine the network coordinates of each Domain Controller so that the Dell RCSs can gracefully handle situations where some Domain Controllers are not available on the network. DNS SRV records are used for this purpose so the Dell RCSs always attempt to contact alternative Domain Controllers at the nearest site first, depending on the administrative settings configured in the SRV records.

Object Classes

Within each domain, there is another hierarchy of objects designed to store information about various entities and groupings of entities. Such entities are represented in AD by object classes used to define “containers” that help organize groupings of objects. Other object classes represent entities such as network users, computers, printers, or network services. Two types of container object classes are of special interest: Group and Organizational Unit (OU). These two object classes allow the AD Administrator to define groupings of entities for the purpose of simplifying the application of access controls and other administrative policies. For example, a domain may be configured to have an OU container named Engineering, which contains several Group objects named according to function, like Hardware, Software, and Support; each of the groups is configured with a membership list of User objects and perhaps Computer objects. Yet another level of hierarchy can be configured by nesting groups; a nesting is formed by including the name of a Group object in the membership of another Group object. It should be noted here that each AD Group object has an associated scope that is used to configure the types of nesting relationships it is allowed to have with other groups; for example, when scope is set to Universal, the group may participate in nesting that crosses domain boundaries but when scope is set to Local it may not participate in such nesting. Rules for nesting are available in the AD product documentation available from Microsoft. The suite of Dell RCSs is designed to support all nesting rules defined for AD.

Attributes

There is one more hierarchy used in AD. Associated with each object class is a set of “attributes” used to store specific information about the entity that is being represented. For example, associated with the User object class is an attribute type named SAM ACCOUNT NAME and others such as FIRST NAME, SURNAME, PASSWORD, etc. The suite of Dell Remote Console Switches uses the SAM ACCOUNT NAME and PASSWORD attributes to authenticate a user (the formal AD names for these two attributes are sAMAccountName and unicodePWD, respectively).

Schema Extensions

AD is packaged with many object classes, including default containers for Computer and User objects as well as classes for OU containers and classes to represent computer and user entities. AD can be extended to include new object classes such as those provided by Dell to simplify the administration of access controls; such extensions are usually referred to as “schema extensions” and are at the heart of the Dell Extended Schema feature described in this document. These schema extensions provide customized object classes to represent Dell RCSs, access control information, and a type of container used to associate specific access control information with specific instances of Dell RCSs and Users. It is important to note that each attribute type and object class used in AD must have a globally unique identifier, known as an Object Identifier (OID). These unique identifiers are ultimately managed by internationally recognized authorities. For AD, the OID space is managed secondarily by Microsoft. Dell has obtained OIDs for the custom object classes and attribute types used in the Dell Extended Schema feature. The following is a summary of the OIDs Dell obtained:

Dell extension is: dell

Dell base OID is: 1.2.840.113556.1.8000.1280

RCS LinkID range is: 12070 to 12079

The suite of Dell RCSs is also designed to function using only object classes present in the AD packaged classes; this option is known as the Standard Schema. Under this option, the Computer object class is used to represent Dell RCSs and standard Group objects are used to associate specific access control information with specific instances of Dell RCSs and Users. In this case, access control information is stored in a specific attribute type in the Group object.

The hierarchical structures present in AD can complicate your ability to access information stored in the directory objects. To avoid potential delays associated with navigation of the hierarchies, the suite of Dell Remote Console Switches is designed to use an aspect of AD known as the Global Catalog (GC). The GC provides a “quick look-up” service by providing access to a subset of the data stored in the complete AD database and by “collapsing” all of the hierarchies and geographic distribution into a single relatively flat structure. The GC is queried using the same LDAP directory queries that work on the complete AD database. The AD product requires at least one of the Domain Controllers in an enterprise to also be configured to provide GC services and actual deployments of AD can have any or all of the Domain Controllers configured to provide GC services. The suite of Dell RCSs uses DNS to determine the network coordinates of each GC server so that the Dell RCSs can gracefully handle situations where some GC servers are not available on the network. DNS SRV records are used for this purpose so that the Dell RCSs always attempt to contact alternative GC servers at the “nearest” site first, depending on the administrative settings configured in the SRV records.

Standard Schema versus Dell Extended Schema

To provide the greatest flexibility in the multitude of customer environments, Dell provides a group of objects that can be configured by the user depending on the desired results. Dell has extended the schema to include an Association, Device, and Privilege object. The Association object is used to link together the users or groups with a specific set of privileges to one or more SIPs. The Device Object defines the individual RCSs within the Active Directory structure and

the privilege object is linked to device objects via association objects to assign usage permissions.

This model provides an Administrator maximum flexibility over the different combinations of users, privileges, and SIPs on the Remote Console Switch without adding too much complexity.

Before installing the Dell Schema Extensions, Administrators should read through the descriptions and instructions within this chapter to determine which schema is right for their particular installation. Altering a schema object will cause it to propagate through Active Directory so that once it is created, it cannot be deleted. It can only be deactivated. Because of this, the benefits of changing the schema should be carefully weighed before the effort is undertaken.

The primary benefit gained by installing the Dell Schema Extensions is to eliminate confusion. When using the standard Active Directory schema, a Remote Console Switch most closely matches a computer device object and is configured as one. Since the RCS is not a computer, the schema functions will not all apply. Care will have to be taken to correctly configure an RCS that is designated in this manner.

In addition, using the Dell Schema Extensions makes it easier to search on and identify switch devices. A switch that is configured using a computer device object will be searched on along with every computer device within the Active Directory structure.

The RCS can authenticate equally well using either schema and no functionality is lost by using either method. Administrators are free to choose whichever method works within their particular installation. Instructions have been provided for installations with and without the Dell Schema extensions. Sections and instructions that pertain to only one schema set will be marked as such and may be ignored in installations where they are not used.

Standard Installation

Before a Dell RCS can use Active Directory for authentication:

- 1 Configure the Override Admin Account

- 2 Configure DNS Settings
- 3 Set the Network Time Protocol
- 4 Configure the Authentication Parameters
- 5 Configure Group Objects
- 6 Create and Download the CA Root certificate
- 7 Set the Login Timeout

Configure the Override Admin Account

Should a network failure occur, an account is provided that may be used regardless of the unit's ability to authenticate against an LDAP server. Before configuring other settings, this account should be configured. To configure the Override Admin Account in the on-board web interface:

- 1 Click **User Accounts**, then click **Override Admin**.
- 2 Type the username and password you wish to assign to the user and then verify the password by typing it in the **Verify Password** field.
- 3 Click **Save**.



NOTE: You must be logged in as admin for this option.

Configuring DNS Settings

Before the LDAP client can resolve names, at least one DNS server must be specified.

The Network sub-category displays the name of the RCS and allows you to change the network settings including the IP address, Subnet Mask, Gateway, LAN speed and DHCP/BootP setting. The name displayed for the RCS will be the same as the name given in the System Name field in the SNMP category.

The Network sub-category allows the entry and maintenance of up to three DNS Servers. These DNS servers are used to resolve DNS names provided on the LDAP authentication panel.

 **NOTE:** At least one DNS server must be configured for the LDAP feature to work. Whenever a primary server is unavailable, the RCS software will automatically failover to backup DNS servers, as identified here.

 **NOTE:** You can also set DNS server addresses using the RCS's serial administrative interface. For information about using the serial administrative interface, please consult your RCS documentation.

To configure the DNS settings in the on-board web interface:

- 1 Click **DNS** to open the DNS Settings screen.
- 2 Specify the DNS mode, enter the Server addresses, and click **Save**.

Figure 5.1: OBWI - DNS Settings

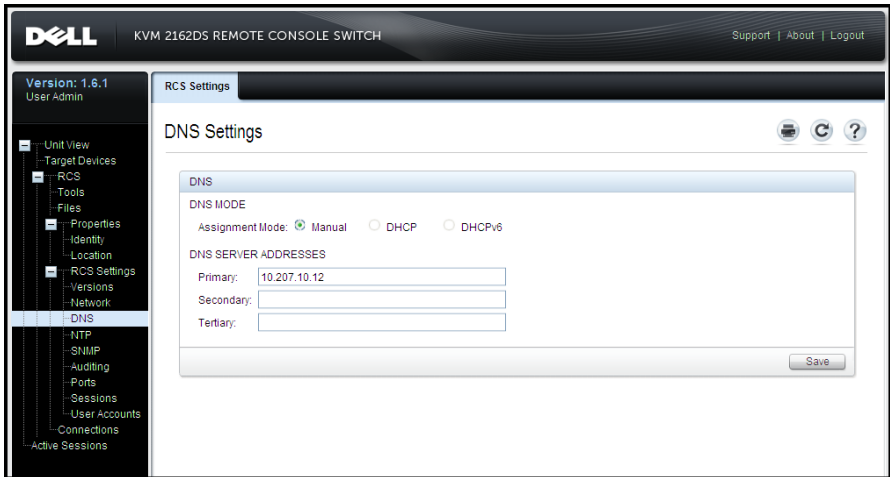

Configuring the Network Time Protocol (NTP) Settings

The switch must have access to the current time to verify that certificates have not expired. You can configure the switch to request time updates from the NTP. To configure NTP settings in the on-board web interface:

- 1 Click **NTP** to open the NTP screen.
- 2 Click the **Enable NTP** box.
- 3 Enter the name of your network time source in the provided boxes. You may also set an hour interval to specify how often to request time updates. If the interval is set to 0, requests will only be made during RCS startup or when changes to the Global - NTP menu are made.
- 4 Click **Save**.

Configuring the LDAP Authentication Parameters

The Authentication panel allows RCS Administrators to configure the parameters required to access LDAP Directory Services. When access requests are received from users, the RCS can use LDAP protocols to send the username, password, and other information to the Directory Service in determining what authorization permissions the user has.



NOTE: The terms for establishing LDAP configuration are, KVM User, KVM User Admin, and KVM Appliance Admin, They are equivalent to User, User Administrator and RCS Administrator, respectively. The access levels have not changed, but use the new terms as directed.

Enabling LDAP Authentication

The Operational Modes section on the LDAP Configuration Options screen allows you to choose the appropriate type of LDAP services to use for user

authentication. The available modes are:

- Standard LDAP directory services (non-Microsoft)
- Microsoft Active Directory services
- Disable LDAP authentication

If an alternate (non-LDAP) authentication method has already been selected for use, then LDAP authentication will automatically be disabled. It will be necessary to deselect this method to use LDAP Directory Services.

To restore the ability to use LDAP authentication:

- 1 Under User Access, select the **Avocent** tab, see Figure 5.2.
- 2 Click **Disassociate** to deselect the use of the Avocent management authentication server.
- 3 Click **Save**.

Figure 5.2: The Avocent Authentication Screen

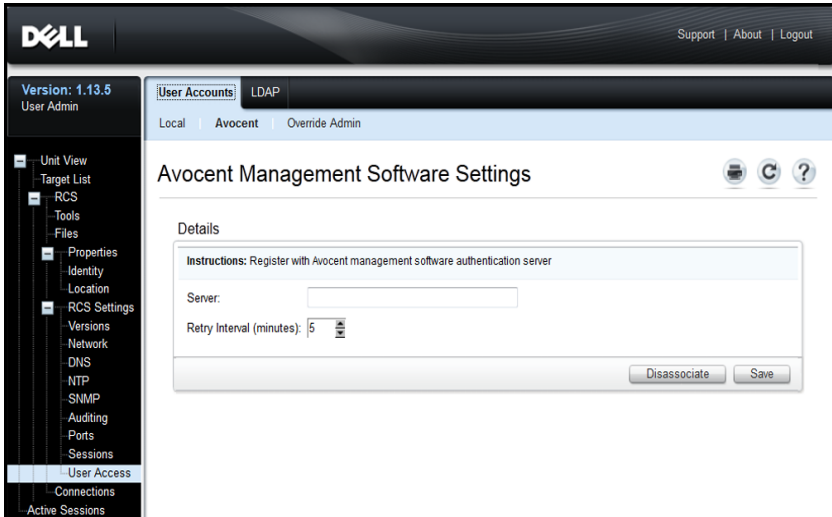



NOTE: It is possible to externally sever the Avocent authentication association without performing these steps. Nonetheless, if an Avocent server association has been created for user authentication, it must be expressly removed via this procedure to permit LDAP authentication configuration to proceed.

To enable LDAP Authentication:

- 1 Under User Access, select the LDAP tab, see Figure 5.3.

Figure 5.3: The LDAP Configuration Options Screen

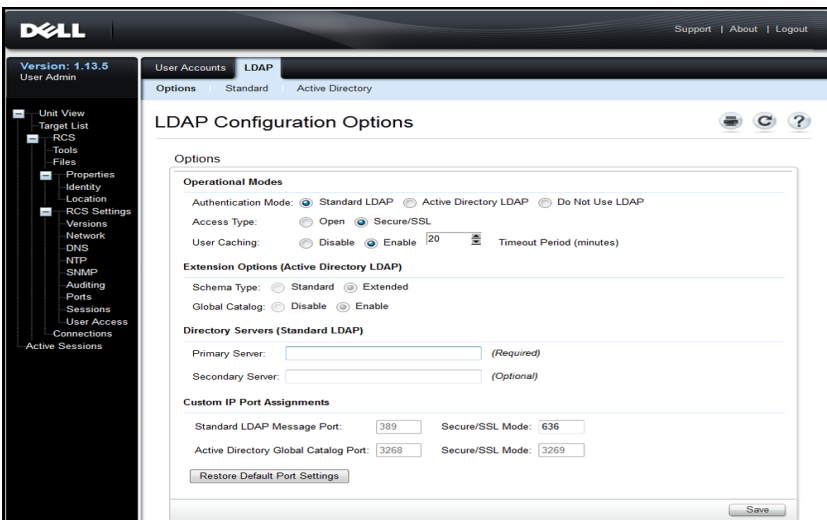

- 2 Select one of the available LDAP Authentication modes in the Operational Modes section.
- 3 Configuration options must be set to fully enable LDAP Authentication for use. Each of the options are detailed in this chapter.
- 4 Click Save.

To disable LDAP authentication, select the **Do Not Use LDAP** option, and click **Save**. All other options on the screen will be disabled; no editing of these

other fields will be permitted. In addition, the additional configuration screens under both the Standard and Active Directory tabs will also be disabled.

When LDAP Authentication is disabled, User Access will be adjudicated by either locally-defined user access lists or Avocent management software (see the section on User Access).

When LDAP Authentication is enabled, locally-defined user access lists take precedence over requests to LDAP Directory Servers. User access requests will first check for RCS-defined users. If no match is found, then requests will be sent to LDAP Directory Servers, as configured.

Entering Authentication Parameters - Operational Modes

Access type

LDAP Directory Servers may be setup to operate either in Open or Secure mode (using SSL - Secure Socket Layer encryption). The mode selected must match that of the host directory server. When selecting Secure/SSL mode, please also see the section entitled LDAP SSL Certificates for guidance on meeting the requirements for encrypted operations.

User caching

Whenever a successful user authentication is completed via LDAP, the RCS has the ability to retain the results obtained from the LDAP Directory Server for a selected period of time. If, during that time window, another access request is generated that normally would result in a repeat request of the Directory Server, such requests are handled locally on board the RCS. This results in a near instantaneous response that will allow the user to continue working with minimal delays.

The three settings for this configuration option are disable, enable, and timeout period.

Disable - do not permit user caching, and always ask the LDAP Directory Server for guidance on the authentication status for every user, every time it is required. By default, User Caching is disabled.

Enable - hold results of recent user authorization requests as determined by the LDAP Directory Server. When identical authorization requests are received within a pre-determined time period, use those prior results to service the new request.

Timeout Period - establishes the duration of the time window. Values are recorded as minutes. Enter only the number in the box, or use the arrow controls.

- Default timeout value: 15 minutes
- Minimum timeout: 1 minute
- Maximum timeout: 1,000 minutes



NOTE: As with all configuration updates, you must click the **Save** to secure your changes. LDAP configuration changes are generally available to the RCS immediately, with no reboot required.

Entering Extension Options - Active Directory LDAP

When Active Directory mode is selected, administrators must determine if the Standard or Extended Schema will be employed. Additionally, administrators should declare whether the Microsoft Global Catalog option will be in use.

Entering Authentication Parameters - Standard LDAP

When using standard LDAP (not Microsoft Active Directory LDAP), direct entry of at least one relevant directory server address is required. Enter the addresses in the Primary Server and Secondary Server fields. The primary server entry is required.

Server addresses may be entered in one of the following forms:

- DNS address (example: myldapservers.com)
- IPv4 address (example: 10.20.255.255)

- IPv6 address (example: fe80::200:f8af:fe20:76ce)

Entering Authentication Parameters - Custom IP Port Assignments

This section permits changes to the industry-standard IP Port numbers conventionally used for LDAP. In most instances, there should be no need to change these values. However, if the administrator of the LDAP Directory Server you are using requires different port assignments, then those may be entered here.

Depending on the exact configuration, LDAP can make use up to four different IP Ports, and as many as two as a time. Slots for each of these four are shown in the LDAP Configuration Options screen. Settings elsewhere on the same screen will be used to identify the ports that can be altered. The following chart defines conditions in which the available port slots are enabled and allowed to be edited.

List of Port Slots that are enabled and may be customized	Open Mode	Secure/SSL Mode
Not using Global Catalog	Standard LDAP Message Port	Standard LDAP Message Port - Secure/SSL Mode
Using Global Catalog	Standard LDAP Message Port and Active Directory Global Catalog Port	Standard LDAP Message Port - Secure/SSL Mode and Active Directory Global Catalog Port - Secure/SSL Mode

Table 5.1: Editing IP Port Assignments

If at any time, the original industry-standard IP Port designations need to be restored, click on the 'Restore Default Port Settings' button. All four Port values will be returned to their original values, which are:

Standard LDAP Message Port - 389

Standard LDAP Message Port via SSL - 636

Active Directory via Global Catalog server - 3268

Active Directory via Global Catalog server/SSL - 3269

IP Port numbers are permitted to range from 1 to 65535. Failure to match up port numbers with those in use by the LDAP Directory Server will result in a failure to establish communications with that server.

Completing LDAP Configuration

For both Standard and Active Directory LDAP modes, additional parameters are required to insure proper connectivity to the LDAP Directory Servers. These parameters are discussed in the following sections. However, you should be aware that there are 'interlocks' established in the OBWI pages to assist the administrator by insuring that parameter updates are made on the appropriate page.

For example, if you were to select the Active Directory LDAP tab, you might see the following display on your screen see Figure 5.4

Figure 5.4: Notification Message - LDAP Mode Not Enabled

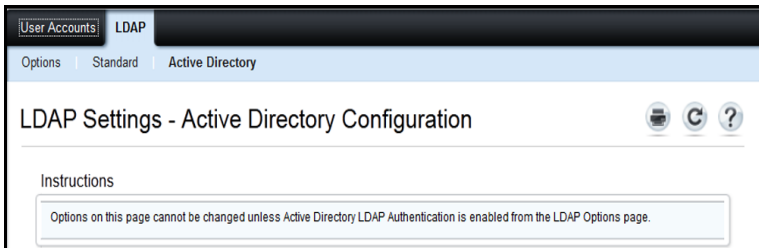

When this happens, it is an indication that the Active Directory mode has not been enabled or it was enabled, but not saved. You should return to the LDAP Options screen, select **Active Directory LDAP**, make note of the secondary parameters for this mode on that page, then click **Save** before returning to this screen.

There is an equivalent display for Standard LDAP mode that appears whenever that mode is not enabled.

Secondary LDAP Settings - Standard Configuration

As with LDAP Active Directory Configurations, Standard LDAP authentication, search, and query parameters are configured through the remote OBWI. Settings in this section are accessed from the User Access / LDAP / Standard tabs via the OBWI window shown here in Figure 5.5

Figure 5.5: Secondary LDAP Settings - Standard Configuration

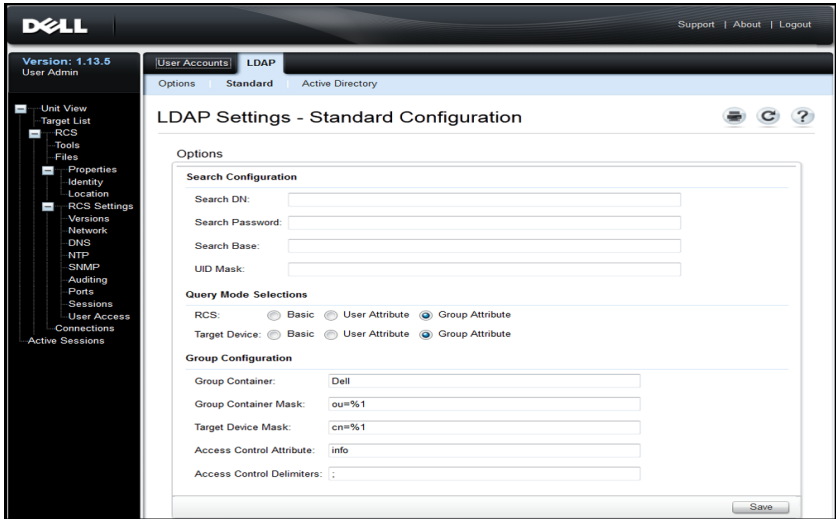

 **NOTE:** While this section describes the setup parameters for connections being made to Standard LDAP Directory Servers, please also note that this section may also be used to establish connections to more generic versions of Active Directory services as well.

Setting up the RCS for performing Standard LDAP queries

 **NOTE:** Before you can use any of the querying modes with Active Directory, you must update Active Directory so that the selected querying mode can assign the applicable authorization level for the user.

To set up group queries:

- 1 Log in to your LDAP Directory Server software with administrator privileges.
- 2 Create an organizational unit (OU) to be used as group container.
- 3 Create a computer object in with a name identical to the switching system name for querying appliances or identical to the attached target devices for querying target devices. The name must match exactly and is case-sensitive.
- 4 The appliance names and target device names used for group queries are stored in the appliance. The appliance name specified in the Appliance Overview screen of the remote OBWI and target device names must be comprised of any combination of upper-case and lower-case letters, digits, and hyphens, and must match the object names on the LDAP Server.
- 5 Create one or more groups under the group container organizational unit.
- 6 Add the usernames and the target device and appliance objects to the groups you created in step four (4).
- 7 Specify the value of an attribute used to implement the Access Control Attribute.

Search Configuration Settings

There are four settings that are required for successful LDAP connections. They are Search DN, Search Password, Search Base, and UID Mask.

Search DN

Search DN defines the administrator-level user that the target device uses to log into the directory service. Once the target device is authenticated, the directory service grants it access to the directory to perform the user authentication queries specified on the LDAP query page. Each search value must be separated by a comma. A typical entry might look like this:

```
cn=Administrator,cn=Users,dc=MyDomainName,dc=com
```

Search password

Search password is used if a password is required for search options. It authenticates the administrator or user specified in the Search DN field. Any printable ASCII characters are allowed.

Search base

Search Base defines a starting point from which all LDAP searches begin. The default values are `dc=yourDomainName` and `dc=com`. Each search component must be separated by a comma. For example, to define a search base for `test.com`, your values are `dc=test, dc=com`.

UID mask

UID mask specifies the search criteria for User ID searches of LDAP target devices. The format is `<name>=<%1>`. The default value is `sAMAccountName=%1`, which corresponds to the default for Microsoft Active Directory services.

Query Mode Selection Settings

Configure the Query Mode parameters for the appliance and target device. The appliance is used to authenticate administrators and users attempting to access the console switch. The target device is used to authenticate users attempting to access attached target devices.

There are three query modes available. They are basic, user attribute, and group attribute.

Basic

A username and password query for the user is sent to the directory service. Once authenticated as a valid user, the user is given access to the appliance and any attached target devices.

User attribute

A username, password, and Access Control Attribute query for the user is sent to the directory service. The Access Control Attribute is read from the user object

in Active Directory. If no values are found, the user is given no access to the appliance or target devices

Group attribute

A username, password, and group query sent to the directory service for an appliance and attached target devices when using Appliance query mode or for a selected target device when using Target Device query mode. If a group is found containing the user and appliance name, the user is given access to either the appliance or target devices when using Appliance query mode. If a group is found containing the user and target device IDs, the user is given access to the selected target device when using Target Device query mode.



NOTE: Depending on the query mode selected, several of the configuration items on this screen may be enabled or disabled according to their applicability.

Group Configuration Parameters

There are several group configuration parameters available.

Group container

The group container specifies the OU created in Active Directory by the administrator as the location for group objects. Group objects can contain users, computers, contacts, and other groups, each assigned with a certain access level.

Group container mask

The group container mask defines the object type of the Group Container, normally an OU. The default value is `ou=%1`.

Target device mask

The target device mask defines a search filter for the target device. The default value is `cn=%1`.

Access control attribute

The access control attribute specifies the name of the attribute used when the query modes are set to User Attribute or Group Attribute. The default attribute

name is "info".

Access control delimiters

The LDAP Standards specify that the semi-colon character (;) is used to separate multiple properties within a single named attribute. Under normal circumstances, this need not be changed. For example, suppose we have a dry-erase-board marker object in the LDAP Directory, and the attribute "Color" is used to identify colors that this marker might have.

```
Color: red;blue;green;black;purple
```

"Color" is the name of the attribute; the rest represents the attribute's value – in this case a compound value. With compound values, the semi-colon is the delimiter used to mark the end of one component and the beginning of the next.

In rare cases, an LDAP Administrator may need the semi-colon to be part of the value itself. In such instances, the Delimiter character has to be changed to something else. If so, use this field to specify all of the characters (at least one character is required; more than one is acceptable) that will identify how the Access Control Attribute should be divided up. For example, the delimiter field is set to **#\$;** (three characters)

```
Color: red#blue$green;black#purple
```

These delimiters would find the same five value components as in the first example above. LDAP Administrators should make sure that any Access Control Delimiter characters defined do not appear as values for any attributes elsewhere for any purpose other than that of delimiter.

As shown above, the Access Control Attribute (ACA) consists of a combination of a name and a value. By default, we search LDAP Directory entries that match up the user and the target device, looking for attributes named 'info'. When found, the value of such attributes should tell us the user's authorization level on that device. If the LDAP Services Administrator wishes to use an attribute other than info, it may be customized via the field indicated above.

Because users may be members of several groups, and each group may have differing authorization levels to different devices, a running tally is kept of the

results. By LDAP standards, the final authorization level reported is the highest (most permissive) level found among all positive results found for the specific user and device under scrutiny.

Secondary LDAP Settings - Active Directory Configuration

Settings in this section are accessed from the User Access / LDAP / Active Directory tabs via the OBWI window shown here in Figure 5.6.

Figure 5.6: Secondary LDAP Settings - Active Directory Configuration

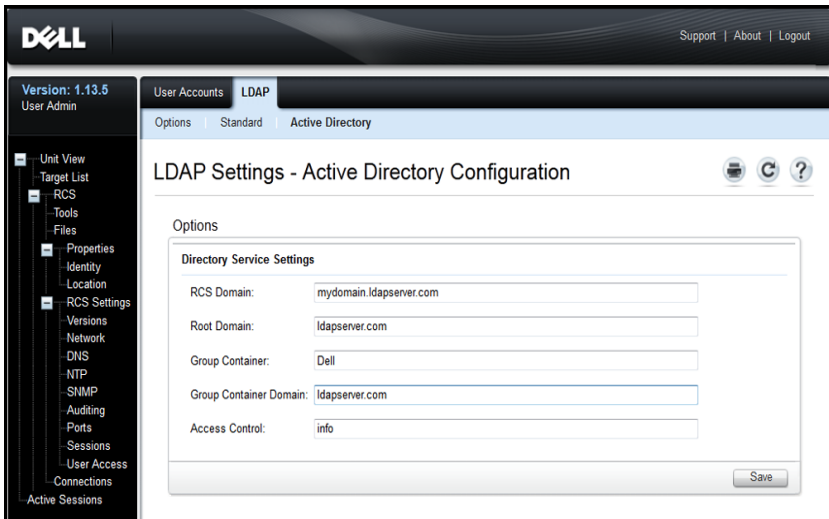

If you plan to install the Dell Extended Schema, enter only the RCS and Root Domains that will be used.

If you elect not to use the Dell Extended Schema, the RCSs and access controlled SIPs in your installation will be configured as Computer Objects within Active Directory. To do this, you will first need to configure an Organizational Unit to hold group objects that relate users to access controlled RCSs and their attached SIPs. This can be a previously created OU, or one created specifically for this purpose but it must be unique among all OU objects in the Group Container domain.

Next, choose an attribute within the LDAP directory to be used to contain discretionary access control information. This should be a previously unused attribute that is capable of storing a string value. (The default is the “info” attribute of the Group Object.)

Finally, you will need to enter the location for the Group Container, the Group Container Domain and the Access Control Attribute in the blanks provided in the Global - Authentication window.

For more detailed descriptions of the Authentication panel fields, see Table 5.2.

To access the Authentication panel in the OBWI:

Click **User Accounts**, then click **LDAP**.

Figure 5.7: OBWI - Authentication Panel Local/LDAP and Parameters

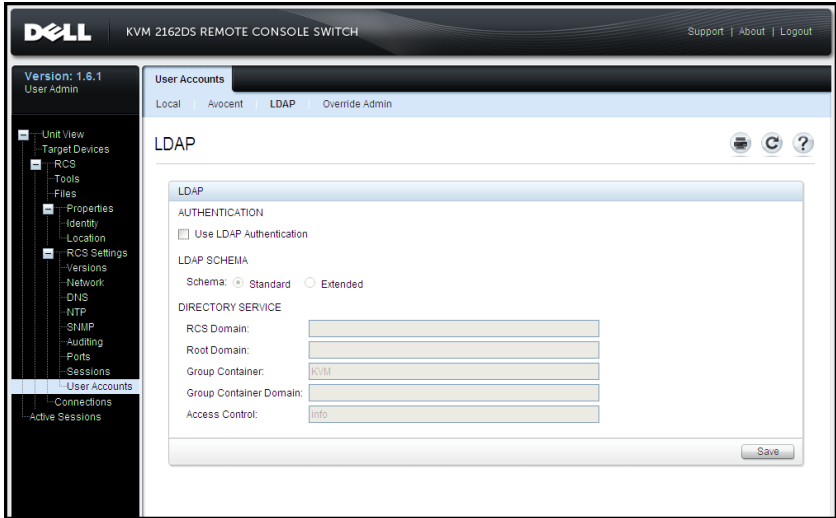

Table 5.2: Authentication Panel Field Descriptions

Field	Description
Authentication Settings	<p>Users can choose to use LDAP authentication by clicking the box shown.</p> <p>The user may still log in with the Override admin account if the LDAP servers are inaccessible.</p>
Schema	<p>Radio Button to indicate which Active Directory (AD) object classes are used to store information related to authorization. For the default Standard schema, Microsoft Active Directory objects are used. When using the Extended schema, the extra Dell object classes are added.</p>
RCS Domain	<p>The RCS Domain field contains the name of the Active Directory Domain chosen to hold all objects that represent RCSs and SIPs.</p>
Root Domain	<p>The uppermost domain within the Active Directory Forest.</p>
Group Container (Standard schema set only)	<p>This field, available when the standard schema is selected, contains part of the Distinguished Name of an Organizational Unit (OU) object in Active Directory. The OU is used to hold group objects that relate users to access controlled Remote Console Switches and their attached SIPs.</p> <p>For example, suppose the Distinguished Name of the chosen OU is: ou=KVM-AccessControls,dc=MyCom,dc=com. In this case, the Group Container field should be set to "KVM-AccessControls." The name entered into the Group Container field must be unique among all OU objects in the Group Container domain. You may choose to use a previously created OU for the Group Container, or create one specifically for this purpose.</p> <p>The default Group Container is KVM.</p>

Field	Description
Group Container Domain (Standard schema set only)	This field, available when the Standard schema is selected, is the DNS name of the Active Directory domain where the group container resides.
Access Control Attribute (Standard schema set only)	<p>The value of this field specifies which attribute in the LDAP directory is to be used to contain discretionary access control information and is only enabled when Standard Schema is selected.</p> <p>The Access Control Attribute is chosen from among the attributes in the LDAP directory object representing the group whose membership includes both the user and the RCS or attached computer that you are trying to access.</p> <p>When using the Standard schema, it is necessary for Group objects in the Group Container to have an attribute that is chosen to contain the permission level associated with the Group. The Access Control Attribute field, available when the Standard schema is selected, contains the name of the chosen attribute. The chosen attribute must be capable of storing a character string value; for example, the default attribute is "info" which is an attribute accessible via the Active Directory Users and Computers (ADUC) snap-in. Using ADUC, the value of the info attribute is set by accessing the "Notes" property of the Group object.</p>

LDAP SSL Certificates

All LDAP protocol exchanges (between an RCS and Active Directory servers) are secured by SSL. When the LDAP protocol is being protected by SSL, it is

referred to as LDAPS (Lightweight Directory Access Protocol over SSL). Each LDAPS connection begins with a protocol handshake that triggers a security certificate transmission from the responding Active Directory server to the RCS. Once received, the RCS is responsible for verifying the certificate. In order to verify the certificate, the RCS must be configured with a copy of the root Certification Authority's (CA) certificate. Before this can be done, the certificate must first be generated.

Enabling SSL on a Domain Controller

If you plan to use Microsoft Enterprise Root CA to automatically assign all your domain controllers SSL certificate, you must perform the following steps to enable SSL on each domain controller if you have not previously done so.

- 1 Install a Microsoft Enterprise Root CA on a Domain Controller.
 - a. Select **Start - Control Panel - Add or Remove Programs**.
 - b. Select **Add/Remove Windows Components**.
 - c. In the Windows Components Wizard, select the **Certificate Services** checkbox.
 - d. Select **Enterprise root CA** as CA Type and click **Next**.
 - e. Enter Common name for this CA, click **Next**, and click **Finish**.
- 2 Enable SSL on each of your domain controllers by installing the SSL certificate for each controller.
 - a. Click **Start - Administrative Tools - Domain Security Policy**.
 - b. Expand the Public Key Policies folder, right-click **Automatic Certificate Request Settings** and click **Automatic Certificate Request**.
 - c. In the Automatic Certificate Request Setup Wizard, click **Next** and select **Domain Controller**.
- 3 Click **Next** and click **Finish**.

A certificate/private key file can be created using openssl using Linux. Openssl can be downloaded from openssl.org. Any instructions below with text in <> is

where a user would need to set a value based on the criteria at the end of that line.

 **NOTE:** Any instructions below with text in <anglebrackets> is where a user would need to set a value based on the criteria at the end of that line.

To create a certificate to import:

- 1 From the Linux command prompt, type **openssl** and press <Enter>. The user should be at the OpenSSL prompt.

```
OpenSSL> genrsa -out privatekey.pem <512>
Generating RSA private key, 512 bit long modulus
.....+++++
....+++++
e is 65537 (0x10001)
```

```
OpenSSL> req -new -key privatekey.pem -x509 -out certificate.pem-
batch-days <365>
```

- 2 Enter the information that will be incorporated into your certificate request in the Distinguished Name or DN. There may be a default value for some fields. If you wish, you may type '!' to leave a field blank.

```
-----
Country Name (2 letter code) [GB]:<US>
State or Province Name (full name) [Berkshire]:<Texas>
Locality Name (eg, city) [Newbury]:<Austin>
Organization Name (eg, company) [My Company Ltd]:<Dell, Inc.>
Organizational Unit Name (eg, section) []:<Round Rock>
Common Name (eg, your name or your server's hostname) []:<RCS
DNS Name or IP>
Email Address []:<support@dell.com>
OpenSSL> quit
```

- 3 From the Linux command prompt, type `cat certificate.pem privatekey.pem > webserver.pem`, then convert the file from UNIX linefeed to DOS carriage return/linefeed by typing `unix2dos webserver.pem`.

To export the CA certificate:

- 1 Within the Windows operating system, to open the Certificate Authority management tool, click **Start - All Programs - Administrative Tools - Certificate Authority**.
- 2 You may view properties of the certificate authority by right clicking on the authority in the tree view and selecting **Properties**. The CA Properties dialog box will open.
- 3 Click the **General** tab and the **View Certificate** button to open the Certificate dialog box.
- 4 Click the **Details** tab then the **Copy To File** button. The Certificate Export Wizard will open.
- 5 Click **Next** to begin using the wizard.
- 6 On the Export File Format screen select the **Base-64 encoded X.509 (.CER)** radio button and press the **Next** button.
- 7 On the **File To Export** screen enter or browse to a filename and path for the exported certificate. Press the **Next** button.
- 8 Press the **Finish** button.

The resulting certificate file is properly formatted and readable by OpenSSL.

In general, it will be necessary to upload the CA certificate only once; however, it will have to be uploaded again if the certificate is revoked, if it expires, or if “Restore Factory Defaults” is selected from the serial console menu.



NOTE: The instructions above are written for a Microsoft Root CA certificate. For other CAs, please check with the CA vendor.



NOTE: The Network Time Protocol (NTP) must be enabled for LDAPS to function.

Figure 5.8: OBWI - LDAP Certificate

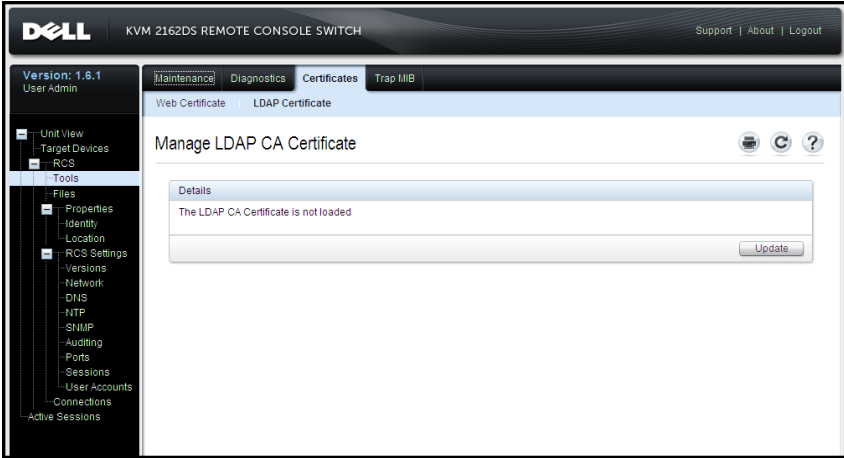

After clicking Update, the following window displays.

Figure 5.9: OBWI - Update LDAP Certificate

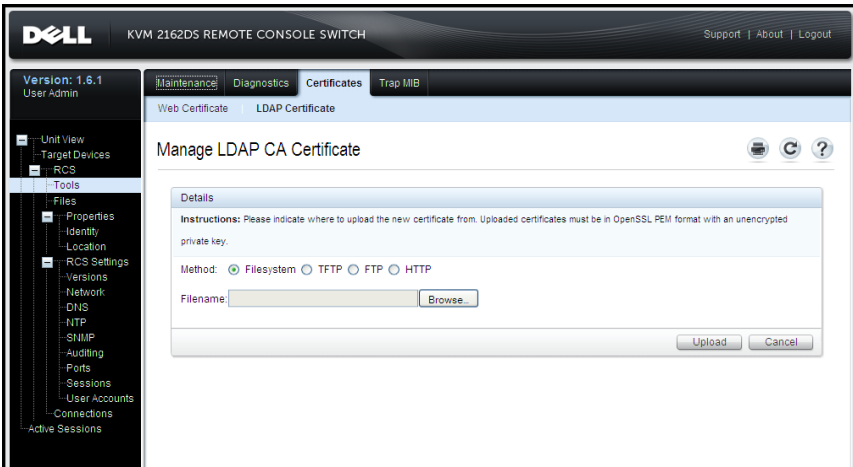

You can browse to a certificate and open it. Once the certificate is open and its contents are displayed, the user can then send the certificate to the RCS.

Login Timeout

In cases where there is a large enough directory tree to cause LDAP authentication to perform slowly, the Sessions window includes a Login Timeout function with a default timeout of 30 seconds. The login timeout is the time from which the user presses the **OK** button on the Login dialog box until there is no response from the RCS. The RCS will also use this value to determine the timeout on a LDAP request for authentication.

To specify the login timeout in the on-board web interface:

- 1 Click Sessions to open the General Session Settings screen.
- 2 Specify the number of seconds in the Login Timeout menu.
- 3 Click Save.

Figure 5.10: OBWI - Login Timeout

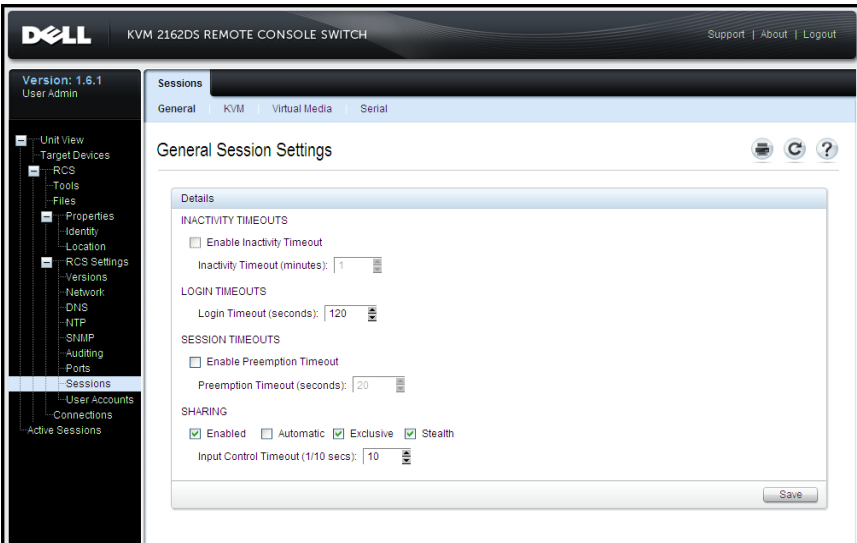

NOTE: The Login Timeout is distinct from the User Login Caching feature. The latter works after a login is completed by caching authorization results for a period of time, eliminating repeated LDAP communications requests.

CA Certificate Information Display

The RCS can only display complete CA Certificate Information in this window when the public key length is less than or equal to 2048 bits. When the key is greater than 2048 bits, the subject, issuer, and validity period data in this window will be incomplete.¹

The following display is an example of the CA certificate information:

- 1 From the Client, download CA certificate into the RCS.
- 2 From the serial console Main Menu, type **option 8** to display the LDAP CA Certificate.

The RCS will display the following types of information:

```
Begin CA certificate information display
subject= /DC=msft/DC=ldaptest/CN=MyCertificate
issuer= /DC=msft/DC=ldaptest/CN=MyCertificate
notBefore=Dec 7 20:09:56 2005 GMT
notAfter=Dec 7 20:18:34 2010 GMT
serial=7BA146C0221A08B447B989292074329F
MD5 Fingerprint=
CB:6D:70:30:31:E5:1B:C0:90:BB:DB:32:B2:C9:D1:5A
End CA certificate information display
```

Perform the steps in the following instructions for enabling the installation of RCS software on Microsoft Windows Server 2003 platforms:

- 1 Select the **Start** menu.
- 2 Right-click on **My Computer** and select **Properties**.
- 3 Select the **Advanced** tab.
- 4 Click the **Performance Settings** button.
- 5 Select the **Data Execution Prevention** tab.

- 6 Select the radio button for **Turn on DEP for essential Windows programs and services only**
- 7 Click **OK**.
- 8 Click **OK** again on the System Properties dialog box.

Configuring Group Objects

Access control is applied to a specific Active Directory user account by including that user in the membership of a Group in the Group Container. The Group membership must also contain the objects representing the RCS(s) and the SIP(s) the user is allowed to access. The level of access granted is determined by the value of a specific attribute in the Group object (Standard Schema) or Association Object (Extended Schema). There are three permission levels available. In increasing order of access they are KVM User, KVM User Admin, and the most powerful level, KVM Appliance Admin.



NOTE: If the KVM User access level is not being used, SIP objects will not need configuration as both administrator permissions have access to all SIPs by default.

Operation	KVM Appliance Admin	KVM User Admin	KVM User
Preemption	Allowed to preempt another KVM Appliance Admin or a KVM User Admin. Permission must be configured for each target device by including the TD in the appropriate Group object in the Directory.	Allowed to preempt another User Admin. Permission must be configured for each target device by including the target device in the appropriate Group object in the Directory.	No
Configure network parameters and global settings	Yes - Permission must be configured for each RCS by including the RCS in the appropriate Group object in the Directory.	No	No
Restart	Yes - Permission must be configured for each RCS by including the RCS in the appropriate Group object in the Directory.	No	No

Operation	KVM Appliance Admin	KVM User Admin	KVM User
FLASH Upgrade	Yes - Permission must be configured for each RCS by including the RCS in the appropriate Group object in the Directory.	No	No
Administer user accounts	Yes - Permission must be configured for each RCS by including the RCS in the appropriate Group object in the Directory.	Yes - Permission must be configured for each RCS by including the RCS in the appropriate Group object in the Directory.	No
Configure port settings	Yes - Permission must be configured for each RCS by including the RCS in the appropriate Group object in the Directory.	No	No

Operation	KVM Appliance Admin	KVM User Admin	KVM User
Target Device Access	Yes - Permission must be configured for each RCS by including the RCS in the appropriate Group object in the Directory.	Yes - Permission must be configured for each RCS by including the RCS in the appropriate Group object in the Directory.	Yes, if configured by Administrator. Permission must be configured for each target device by including the TD in the appropriate Group object in the Directory.

Table 5.3: Allowed Operations by Access Level

An AD user account must be configured to receive RCS Administrator (KVM Appliance Admin) permission before that account will be allowed to modify any of the fields in the Authentication Panel. In particular, only an RCS Administrator is allowed to modify the Authentication Settings.

Active Directory Object Overview for Standard Schema

For each of the physical RCSs on the network that you want to integrate with Active Directory for Authentication and Authorization, you must create at least one Computer Object to represent it. You will also need to create a computer object for each SIP attached to the RCS that will be controlled using the KVM User privilege level. Computer objects representing SIPs are not required for the Administrator level groups. Users in the KVM User Group will only have access to SIPs that are also in the KVM User Group. Users with Administrator privileges will have access to all SIPs by default.

To set up the Group Objects for an RCS:

- 1 If you have not already, create the Organizational Unit that will contain the Group Objects related to your switch installation.
- 2 Within this Organizational Unit, create three group objects to represent user privilege levels. One for KVM Appliance Administrators, KVM User Administrators and KVM Users, respectively.
- 3 Using the MSADUC tool, open the KVM Appliance Administrator Group Object and select the Notes property. Type the access level ("KVM Appliance Admin") for that group in the Notes field and save. Repeat this step for the other two Group Objects using their respective names.



NOTE: The single syntax for all access control attribute values is:

```
"[<arbitrary text string> <delimiter>] < privilege level>
[<delimiter> <arbitrary text string>]"
```

Where: <privilege level> := "KVM User" or "KVM User Admin" or "KVM Appliance Admin"

<delimiter> ::= one or more of any of the following: <newline> or <c/r> or <comma> or <semicolon> or <tab>

<arbitrary text string> is any string of alphanumeric characters and may be the null (i.e., empty) string.

Square brackets indicate optional items; for example, the following template indicates an optional string and delimiter followed by a required privilege level: "[<arbitrary text string> <delimiter>] < privilege level >".

- 4 Create a computer object to represent the RCS.
- 5 Create a computer object for each SIP attached to a server to be access restricted at the KVM User privilege level.
- 6 Add the computer object that represents the switch to the appropriate group objects.
- 7 Add user objects to the appropriate group object for their access level.
- 8 Add the computer objects for the access controlled SIPs to the KVM User Group.

Dell Extended Schema Active Directory Object Overview

For each of the physical RCSs on the network that you want to integrate with Active Directory for Authentication and Authorization, you must create at least one RCS Device Object to represent the physical switch and one Association Object. The Association object is used to link together the users or groups with a specific set of privileges to one or more SIPs. This model provides an Administrator maximum flexibility over the different combinations of users, RCS privileges, and SIPs on the Remote Console Switch without adding too much complexity.

The RCS Device Object is the link to the RCS for querying Active Directory for authentication and authorization. When a RCS is added to the network, the Administrator must configure the RCS and its device object with its Active Directory name so that users can perform authentication and authorization with Active Directory. The Administrator will also need to add the Remote Console Switch to at least one Association Object in order for users to authenticate.

You can create as many Association Objects as you want, and each Association Object can be linked to as many users, groups of users, or RCS Device Objects as desired. The users and RCS Device Objects can be members of any domain in the enterprise.

However, each Association Object may be linked (or, may link users, groups of users, or RCS Device Objects) to only one Privilege Object. A Privilege Object allows an Administrator to control which users have what kind of privileges on specific SIPs.

The following figure illustrates that the Association Object provides the connection that is needed for all of the Authentication and Authorization.

Figure 5.11: Typical Setup for Active Directory Objects

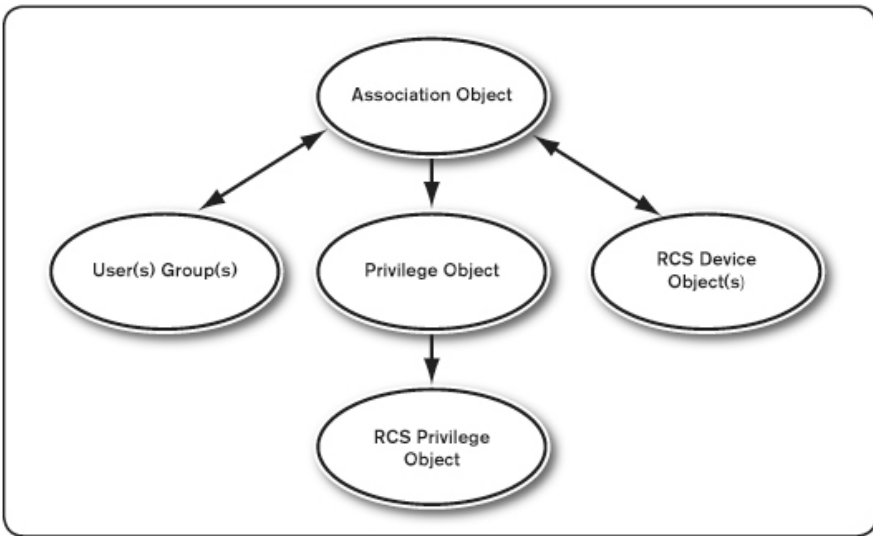

You can create as many or as few association objects as you want or need. However, you must create at least one Association Object, and you must have one RCS Device Object for each RCS on the network that you want to integrate with Active Directory for Authentication and Authorization. The Association Object allows for as many or as few users and/or groups as well as RCS Device Objects. However, the Association Object only has one Privilege Object per Association Object. The Association Object connects the users who have privileges on the RCSs.

In addition, you can set up Active Directory objects in a single domain or in multiple domains. For example, you have two RCSs (RCS1 and RCS2) and three existing Active Directory users (User1, User2, and User3). You want to give User1 and User2 an Administrator privilege to both RCSs and give User3 a login privilege to the RCS2.

The following figure illustrates how to set up the Active Directory objects in this scenario.

Figure 5.12: Setting Up Active Directory Objects in a Single Domain

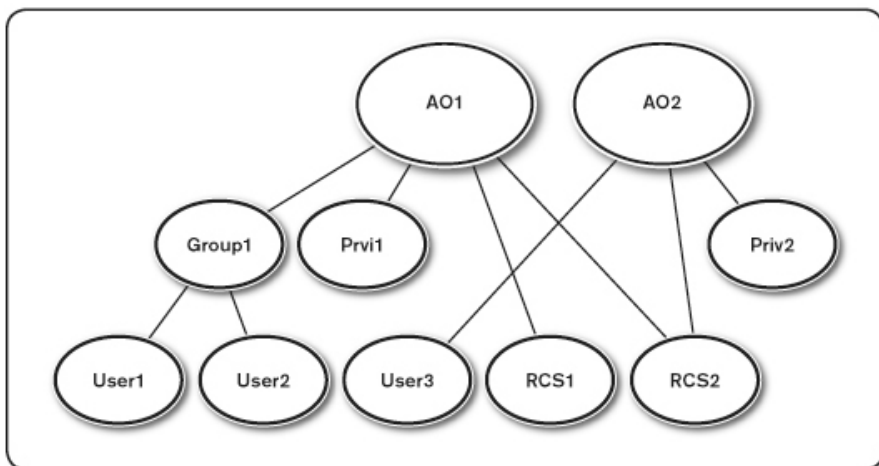

To set up the objects for the single domain scenario, perform the following tasks:

- 1 Create two Association Objects.
- 2 Create two RCS Device Objects, RCS1 and RCS2, to represent the two RCSs.
- 3 Create two Privilege Objects, Priv1 and Priv2, in which Priv1 has all privileges (Administrator) and Priv2 has login privileges.
- 4 Group User1 and User2 into Group1.
- 5 Add Group1 as Members in Association Object 1 (AO1), Priv1 as Privilege Objects in AO1, and RCS1 and RCS2 as RCS Devices in AO1.
- 6 Add User3 as Members in Association Object 2 (AO2), Priv2 as Privilege Objects in AO2, and RCS2 as RCS Devices in AO2.

See “Adding RCS Users and Privileges to Active Directory with Dell Schema Extensions” for detailed instructions.

The following figure illustrates how you can set up the Active Directory Objects in multiple domains. In this scenario, you have two RCSs (RCS1 and RCS2) and three existing Active Directory users (User1, User2, and User3).

User1 is in Domain1, and User2 and User3 are in Domain2. You want to give User1 and User2 an administrator privilege to both RCSs and give User3 a login privilege to the RCS2.

Figure 5.13: Setting Up Active Directory Objects in Multiple Domains

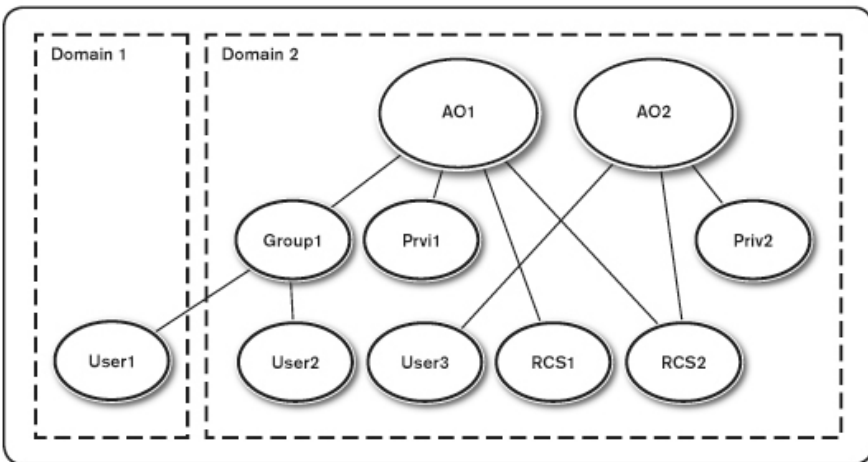

To set up the objects for the multiple domain scenario, perform the following tasks:

- 1 Ensure that the domain forest function is in Native or Windows 2003 mode.
- 2 Create two Association Objects, AO1 (of Universal scope) and AO2, in any domain. The figure shows the objects in Domain2.
- 3 Create two RCS Device Objects, RCS1 and RCS2, to represent the two RCSs.

- 4 Create two Privilege Objects, Priv1 and Priv2, in which Priv1 has all privileges (Administrator) and Priv2 has login privileges.
- 5 Group User1 and User2 into Group1. The group scope of Group1 must be Universal.
- 6 Add Group1 as Members in Association Object 1 (AO1), Priv1 as Privilege Objects in AO1, and RCS1, RCS2 as RCS Devices in AO1.
- 7 Add User3 as a Member in Association Object 2 (AO2), Priv2 as Privilege Objects in AO2, and RCS2 as RCS Devices in AO2.

Configuring Active Directory with Dell Schema Extensions to Access Your RCS

Before you can use Active Directory to access your RCS, you must configure the Active Directory software and the Remote Console Switch by performing the following steps in their numbered order:

- 1 Extend the Active Directory schema.
- 2 Extend the Active Directory Users and Computers Snap-in.
- 3 Add RCS users and their privileges to Active Directory.

Extending the Active Directory Schema (Optional)

Extending your Active Directory schema will add a Dell organizational unit, schema classes and attributes, and example privileges and association objects to the Active Directory schema.



NOTE: Before you extend the schema, you must have Schema Admin privileges on the Schema Master Flexible Single Master Operation (FSMO) Role Owner of the domain forest.

You can extend your schema using two different methods. You can use the Dell Schema Extender utility or you can use the LDIF script file.



NOTE: The Dell organizational unit will not be added if you use the LDIF script file.

The LDIF files and Dell Schema Extender can be obtained at dell.com/support.

To use the LDIF files, see the instructions in the readme that is in the LDIF files directory. To use the Dell Schema Extender to extend the Active Directory Schema, perform the steps in “Using the Dell Schema Extender.”

You can copy and run the Schema Extender or LDIF files from any location.

Using the Dell Schema Extender



NOTE: The Dell Schema Extender uses the SchemaExtenderOem.ini file. To ensure that the Dell Schema Extender utility functions properly, do not modify the name of this file.

- 1 Click **Next** on the Welcome screen.
- 2 Read the warning and click **Next** again.
- 3 Either select **Use Current Log In Credentials** or enter a user name and password with schema administrator rights.
- 4 Click **Next** to run the Dell Schema Extender.
- 5 Click **Finish**.

Installing the Dell Extension to the Active Directory Users and Computers Snap-In (Optional)

When you extend the schema in Active Directory, you must also extend the Active Directory Users and Computers snap-in so that the administrator can manage RCS devices, Users and User Groups, RCS Associations, and SIP Privileges. The Dell Extension to the Active Directory User’s and Computers Snap-In is an option that can be installed when you install your systems management software using the Dell Systems Management Consoles CD. See the Dell OpenManage Software Quick Installation Guide for further instructions on installing systems management software.



NOTE: You must install the Administrator Pack on each system that is managing the Active Directory RCS Objects. The installation is described in the following section, “Opening the Active Directory Users and Computers Snap-In.” If you do not install the Administrator Pack, then you cannot view the Dell SIP Object in the container.



NOTE: For more information about the Active Directory Users and Computers snap-in, see your Microsoft documentation.

Opening the Active Directory Users and Computers Snap-In

To open the Active Directory Users and Computers snap-in, perform the following steps:

If you are on the domain controller, click **Start -Admin Tools - Active Directory Users and Computers**

- or -

If you are not on the domain controller, you must have the appropriate Microsoft Administrator Pack installed on your local system. To install this Administrator Pack, click **Start - Run**, type <MMC> and press <Enter>. This opens the Microsoft Management Console (MMC).

- 1 Click **File** (or **Console** on systems running Windows 2000) in the Console 1 window.
- 2 Click **Add/Remove Snap-in**.
- 3 Select the **Active Directory Users and Computers snap-in** and click **Add**
- 4 Click **Close** and click **OK**.

Adding Users and Privileges to Active Directory with Dell Schema Extensions

The Dell-extended Active Directory Users and Computers snap-in allows you to add RCS users and privileges by creating SIP, Association, and Privilege objects. To add each type of object, perform the steps in each subsections.

Creating a SIP Object

- 1 In the MMC Console Root window, right-click a container.
- 2 Select **New - Dell SIP Object**. This opens the New Object window.

- 3 Type a name for the new object. This name must match the RCS name that you will type in step 4 of "Configuring the Remote Console Switch" on page 38.
- 4 Select **SIP Device Object**.
- 5 Click **OK**.

Creating a Privilege Object

Privilege Objects must be created in the same domain as the Association Object to which it is associated.

- 1 In the Console Root (MMC) window, right-click a container.
- 2 Select **New - Dell SIP Object** to open the New Object window.
- 3 Type a name for the new object.
- 4 Select **Privilege Object**.
- 5 Click **OK**.
- 6 Right-click the privilege object that you created, and select **Properties**.
- 7 Click the **RCS Privileges** tab and select the RCS privileges that you want the user to have.

Using Dell Association Objects Syntax

Using the Dell Association Objects syntax, object types default to User and Group in the Dell LDAP Schema. In the Dell Extended Schema, Dell has added unique Object IDs for four new object classes:

- KVM RCS Objects
- KVM SIP Objects
- Privilege Objects
- Association Objects

Each of these new object classes is defined in terms of various combinations (hierarchies) of default Active Directory classes, together with Dell unique attribute types. Each of the Dell unique attribute types is defined in terms of a default Active Directory attribute syntax.

The default Microsoft Active Directory object classes used include User and Group. The User class generally denotes Active Directory objects that contain information about single entities. The Group class represents containers used for nesting and contain information about collections of objects.

Each KVM RCS Object represents an individual Remote Console Switch within Active Directory. Since these are single entities, in the LDAP default language they are User objects rather than Group objects.

Each Privilege Object defines a distinct composite set of privileges. Each set is treated as a discrete entity, therefore it is a User object rather than a Group object.

An Association Object contains a collection of information about the privileges granted to specific user accounts with respect to a specific RCS(s) and/or specific SIP(s). User accounts in an RCS Object may be specified in terms of any combination of the following:

- Individual account
- Active Directory security group of user accounts

- Multiple Active Directory security groups of user accounts

Similarly, for the RCSs and/or SIPs in an Association Object and because the Association Object has the ability to use security groups in the same way, it is defined as a group object itself.

Creating an Association Object

The Association Object is derived from a Group and must contain a Group Type. The Association Scope specifies the Security Group Type for the Association Object. When you create an Association Object, you must choose the Association Scope that applies to the type of objects you intend to add. Selecting Universal, for example, means that association objects are only available when the Active Directory Domain is functioning in Native Mode or above.

To create an association object:

- 1 In the Console Root (MMC) window, right-click a container.
- 2 Select **New - Dell SIP Object** to open the New Object window.
- 3 Type a name for the new object.
- 4 Select **Association Object**.
- 5 Select the scope for the Association Object.
- 6 Click **OK**.

Adding Objects to an Association Object

By using the Association Object Properties window, you can associate users or user groups, privilege objects, and SIP devices or SIP device groups.



NOTE: When using Windows 2000 mode or higher, you must use Universal Groups to span domains with your users or SIP objects.

You can add groups of Users and SIP devices. Creating Dell-related groups is done the same way you create other groups.

To add users or User Groups:

- 1 Right-click the Association Object and select **Properties**.
- 2 Select the **Users** tab and click **Add**.
- 3 Type the user or User Group name and click **OK**.

Click the Privilege Object tab to add the privilege object to the association that defines the user's or user group's privileges when authenticating to a SIP device.

 **NOTE:** You can add only one privilege object to an association object.

To add a privilege:

- 1 Select the **Privileges Object** tab and click **Add**.
- 2 Type the Privilege Object name and click **OK**.

Click the Products tab to add one or more SIP devices to the association. The associated devices specify the SIP devices connected to the network that are available for the defined users or user groups.

 **NOTE:** You can add multiple SIP devices to an association object.

To add SIP devices or SIP device groups:

- 1 Select the **Products** tab and click **Add**.
- 2 Type the SIP device or SIP device group name and click **OK**.
- 3 In the Properties window, click **Apply** and then **OK**.

Console Redirection Access Security

In any RCS installation, any user privilege allows the user to launch the on-board web interface. The on-board web interface functionality for that user is limited by the User Privilege level established in the RCS. LDAP with Dell Extended Schema adds an extra level of security to RCS management by allowing administrators to limit a user's access to the on-board web interface.

Authorization to use the on-board web interface is defined by whether User Privilege level is or is not configured in the KVM RCS Privileges tab of the Dell Privilege Object (DPO). The Console Redirection Access checkbox in the KVM

SIP Privileges tab of the DPO provides the means for a user who cannot view the on-board web interface to launch Video Viewer sessions to a subset of SIPs through the RCS Client. This authorization is controlled by a combination of the configuration parameters set in the DPO and the SIP Objects contained in the Dell Association Object (DAO).

If you do not wish a user to have authorization to access the on-board web interface, but you do wish them to be able to launch viewer sessions from the RCS Client, perform the following steps:

- 1 Create a Dell SIP object for each SIP that the User(s) is (are) allowed to access.
- 2 Create an Active Directory User account for each of the users to be controlled.
- 3 Create a DPO. Do not check any of the three boxes on the KVM RCS Privileges tab. Check the Console Redirection Access box on the KVM SIP Privileges tab.
 **NOTE:** If you check any of the KVM RCS Privileges checkboxes and you check the Console Redirection Access box, the normal User Privileges associated with the privilege level checked in the KVM RCS Privileges box will take precedence over the Console Redirection Access checkbox, and the user will still be able to view the AMP.
- 4 Create a DAO.
- 5 Open the properties dialog for the DAO created in step 4.
 - a. Add all the user accounts created in step 2.
 - b. Add the DPO created in step 3.
 - c. Add the SIP objects created in step 1.

Using Active Directory to Log In to the RCS

You can use Active Directory to log in to the RCS through the RCS software or OBWI.

The login syntax is consistent for all three methods:

<username@domain> or <domain>\<username> or <domain>/<username> (where username is an ASCII string of 1–256 bytes). No white space and no special characters (such as \, /, or @) are allowed in either the username or the domain name.

 **NOTE:** You cannot specify NetBIOS domain names, such as Americas, since those names cannot be resolved.

 **NOTE:** If a domain name is not included, the local database in the Remote Console Switch will be used to authenticate the user.

Target Device Naming Requirements for LDAP Implementation

If you experience the following error:

Login Failure. Reason: Access cannot be granted due to Authentication Server errors

Please verify that the SIP object was created in the Active Directory and its name exactly matches the name assigned to that SIP via the OBWI at the console switch.

The Dell Standard Schema and the Dell Extended Schema use specific object classes in the Microsoft Windows Active Directory to represent SIPs. The Microsoft standard naming conventions for these object classes prohibit the use of special characters or spaces. If you intend to use LDAP in a deployed environment where target device names in SIPs currently include spaces or special characters, you will need to rename them without spaces or special characters.

Renaming a target device in a SIP should be done through the OBWI at the console switch and then resynchronized through the RCS software. It is important to note that while the OBWI will allow you to enter spaces into the names assigned to the SIPs, Active Directory does not. You must name SIP objects according to the Microsoft Active Directory rules.

Frequently Asked Questions

The following table lists frequently asked questions and answers.

Can I log into the Remote Console Switch using Active Directory across multiple forests?	The RCS Active Directory query algorithm only supports a single tree in a single forest.
Does the login to the Remote Console Switch using Active Directory work in mixed mode (that is, the domain controllers in the forest run different operating systems, such as Microsoft Windows NT® 4.0, Windows 2000, or Windows Server 2003)?	Yes. In mixed mode, all objects used by the RCS querying process (among user, SIP Device Object, and Association Object) have to be in the same domain. The Dell-extended Active Directory Users and Computers snap-in checks the mode and limits users in order to create objects across domains if in mixed mode.
Does using the RCS with Active Directory support multiple domain environments?	Yes. The domain forest function level must be in Native mode or Windows 2003 mode. In addition, the groups among Association Object, Remote Console Switch user objects, and SIP Device Objects (including Association Object) must be universal groups.

Can these Dell-extended objects (Dell Association Object, Dell Remote Console Switch Device, and Dell Privilege Object) be in different domains?

The Association Object and the Privilege Object must be in the same domain. The Dell-extended Active Directory Users and Computers snap-in forces you to create these two objects in the same domain. Other objects can be in different domains.

Are there any restrictions on Domain Controller SSL configuration?

Yes. All Active Directory servers' SSL certificates in the forest must be signed by the same root CA since RCS only allows uploading one trusted CA SSL certificate.

What can I do if I cannot log into the RCS using Active Directory authentication? How do I troubleshoot the issue?

Troubleshoot as follows:

- If no domain name is specified, the local database is used. To login when AD authentication isn't working, use the default local admin account.
 - Ensure that you have checked the Enable Active Directory checkbox (RCS Software) or the Use LDAP Authentication checkbox (on-board web interface) on the RCS Active Directory configuration page.
 - Ensure that the DNS setting is correct on the RCS Networking configuration page.
 - Ensure Network Time Protocol is enabled on at least one server specified on the NTP panel.
 - Ensure that you have uploaded the Active Directory certificate from your Active Directory root CA to the RCS.
 - Check the Domain Controller SSL certificates to ensure that they have not expired.
 - Ensure that your "Remote Console Switch Name", "Root Domain Name", and "RCS Domain Name" match your Active Directory environment configuration.
 - Ensure that you use the correct user domain name during a login and not the NetBIOS name.
-

Appendix A: Terminal Operations

Each RCS may be configured at the switch level through the Console menu interface accessed through the SETUP port. All terminal commands are accessed through a terminal or PC running terminal emulation software.



NOTE: The preferred method is to make all configuration settings in the local UI.

To connect a terminal to the switch:

- 1 Using the supplied RJ-45 to DB-9 (female) adaptor and flat RJ-45 cable, connect a terminal or a PC that is running terminal emulation software (such as HyperTerminal) to the SETUP port on the back panel of the switch. The terminal settings are 9600 bits per second (bps), 8 bits, 1 stop bit, no parity and no flow control.
- 2 Turn on each target device and then turn on the switch. When the switch completes initialization, the Console menu will display the following message: **Press any key to continue.**

Console Boot Menu Options

While the switch is turning on, you can press a key to view the boot menu. From this menu, you can choose one of four options.

- Boot Normal
- Boot Alternate Firmware
- Reset Factory Defaults

- Full-Factory Reset

Console Main Menu Options

Once turned on, the main menu displays the product name and version. From this menu, you can choose one of four options.

- Network configuration: This menu option allows you to configure the network setting of the RCS.
- Debug messages: This menu option turns on console status messages. Because this can significantly reduce performance, you should only enable debug messages when instructed to do so by Dell Technical Support. When you are finished viewing the messages, press any key to exit this mode.
- Reset RCS: This menu option allows you to execute a soft reset of the switch.
- Exit: This menu selection will return you to the ready prompt. If the Console menu interface password is enabled, you must exit the Console main menu so that the next user will be prompted with the Username and Password login screen.

Appendix B: Using SIPs

An administrator can choose between the Avocent ACS console server and Cisco pinouts for each serial SIP port via the local user interface or the remote OBWI. ACS is the default.

To change the pinout to Cisco mode:

- 1 Select **Unit View - RCS - RCS Settings - Ports - SIPs**.
- 2 Click on the desired SIP.
- 3 Select **Settings - Pinout**.

 **NOTE:** If the DB-9 adaptor is used, select the ACS console server pinouts.

ACS Console Server Port Pinouts

The following table lists the ACS console server serial port pinouts for the SIP.

Table B.1: ACS Console Server Serial Port Pinouts

Pin No.	Signal Name	Input/Output
1	RTS - Request to Send	OUT
2	DTR - Data Terminal Ready	OUT
3	TXD - Transmit Data	OUT
4	GND - Signal Ground	N/A
5	CTS - Clear to Send	IN

Pin No.	Signal Name	Input/Output
6	RXD - Receive Data	IN
7	DCD/DSR - Data Set Ready	IN
8	N/C - Not Connected	N/A

Cisco Port Pinouts

The following table lists the Cisco serial port pinouts for the SIPs.

Table B.2: Cisco Serial Port Pinouts

Pin No.	Signal Name	Input/Output
1	CTS - Clear to Send	IN
2	DCD/DSR - Data Set Ready	IN
3	RXD - Receive Data	IN
4	GND - Signal Ground	N/A
5	N/C - Not Connected	N/A
6	TXD - Transmit Data	OUT
7	DTR - Data Terminal Ready	OUT
8	RTS - Request to Send	OUT

Appendix C: MIB and SNMP Traps

The Dell RCS has the ability to send audit events to an SNMP Manager. The SNMP traps are defined in an SNMP Trap MIB.

The Trap MIB file may be uploaded from the RCS using the Save Trap MIB function. The uploaded Trap MIB file may then be loaded into an SNMP Trap Receiver application.

Audit events may also be directed to “syslog” destinations. The format of each syslog message is given in the corresponding “--#SUMMARY” comment of each trap defined in the Trap MIB file.

This appendix describes the trap events which the RCS may generate. Although care has been taken to keep the information in this appendix up to date, the Trap MIB file will contain the most accurate trap information.

An SNMP manager may access MIB-II objects of the RCS using the IPv4 or IPv6 protocols.

By design, the enterprise specific MIB objects within the RCS cannot be accessed using SNMP.

The RCS Trap definitions use the structure described in the following Request For Comments (RFCs).

- RFC-1155-SMI

Describes the common structures and identification scheme for the definition of management information for use with TCP/IP-based Internets.

- RFC-1212
Describes the format for producing concise and descriptive MIB modules.
- RFC-1213-MIB
Describes the Internet standard MIB-II for use with network management protocols in TCP/IP-based inter-networks.
- RFC-1215
Describes the SNMP standardized traps and provides a means for defining enterprise-specific traps. The specific objects reported by each trap are defined in the Trap MIB file which is uploaded from the RCS. The following table is a list of the generated trap events.

Table C.1: Generated Trap Events

Trap Event	Trap Number
Reboot Started	1
User Login	2
User Logout	3
Target Session Started	4
Target Session Stopped	5
Target Session Terminated	6
traps 7 through 9 are deprecated	7-9
Image File Upgrade Started	10
Image File Upgrade Results	11
User Added	12

Trap Event	Trap Number
User Deleted	13
User Modified	14
User Locked	15
User Unlocked	16
User Authentication Failure	17
SIP Added	18
SIP Removed	19
SIP Moved	20
Target Device Name Changed	21
Tiered Switch Added	22
Tiered Switch Removed	23
Tiered Switch Name Changed	24
Configuration File Loaded	25
User Database File Loaded	26
Ca Certificate Loaded	27
SIP Image Upgrade Started	28
SIP Image Upgrade Result	29
SIP Restarted	30
Virtual Media Session Started	31

Trap Event	Trap Number
Virtual Media Session Stopped	32
Virtual Media Session Terminated	33
Virtual Media Session Reserved	34
Virtual Media Session Unreserved	35
Virtual Media Drive Mapped	36
Virtual Media Drive Unmapped	37
traps 38 through 44 are deprecated	38-44
Screen Resolution Changed	45
Aggregated Target Device Status Changed	46
Factory Defaults Set	47
Power Supply Failure	48
Power Supply Restored	49
Pdu Device Online	50
Pdu Device Offline	51
Pdu Socket On Command	52
Pdu Socket Off Command	53
Pdu Socket Reboot Command	54
Pdu Socket On Sense Fail	55
Pdu Socket Off Sense Fail	56

Trap Event	Trap Number
Pdu Status Socket On	57
Pdu Status Socket Off	58
Pdu Port Name Changed	59
Pdu Socket Name Changed	60
Pdu Input Feed Total Load High	61
Pdu Input Feed Total Load Low	62
Pdu Device Name Changed	63
Pdu Input Feed Name Changed	64
Pdu Socket Lock Command	65
Pdu Socket Unlock Command	66
Pdu Status Socket Lock	67
Pdu Status Socket Unlock	68
Pdu Image File Upgrade Started	69
Pdu Image File Upgrade Result	70
Pdu Circuit Name Changed	71
Pdu Device Total Load High	72
Pdu Circuit Total Load High	73
Pdu Socket Total Load High	74
Fan Failure	75

Trap Event	Trap Number
Temperature Range	76
Smart Card Inserted	77
Smart Card Removed	78

Appendix D: Cable Pinouts Information



NOTE: All switches have the 8-pin modular jack for the modem and console/setup ports.

Modem Pinouts

The modem port pinouts and descriptions are provided in the following figure and table.

Figure D.1: Modem Pinouts

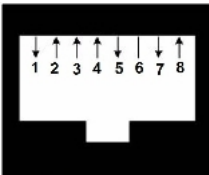

Table D.1: Modem Pinout Descriptions

Pin Number	Description	Pin Number	Description
1	Request to Send (RTS)	5	Transmit Data (TXD)
2	Data Set Ready (DSR)	6	Signal Ground (SG)

Pin Number	Description	Pin Number	Description
3	Data Carrier Detect (DCD)	7	Data Terminal Ready (DTR)
4	Receive Data (RXD)	8	Clear to Send (CTS)

Console/Setup Pinouts

The console/setup port pinouts and descriptions are provided in the following figure and table.

Figure D.2: Console/Setup Pinouts

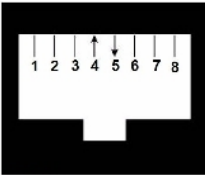

Table D.2: Console/Setup Pinout Descriptions

Pin Number	Description	Pin Number	Description
1	No Connection	5	Transmit Data (TXD)
2	No Connection	6	Signal Ground (SG)
3	No Connection	7	No Connection
4	Receive Data (RXD)	8	No Connection

Appendix E: UTP Cabling

This appendix discusses various aspects of connection media. The RCS system utilizes UTP cabling. The performance of an switch system depends on high quality connections. Poor quality or poorly installed or maintained cabling can diminish switch system performance.



NOTE: This appendix is for information purposes only. Please consult with your local code officials and/or cabling consultants prior to any installation.

UTP Copper Cabling

The following are basic definitions for the three types of UTP cabling that the RCS supports.

- CAT 5 (4-pair) high performance cable consists of twisted pair conductors, used primarily for data transmission. The twisting of the pairs gives this cable some immunity from the infiltration of unwanted interference. CAT 5 cable is generally used for networks running at 10 or 100 Mbps.
- CAT 5E (enhanced) cable has the same characteristics as CAT 5, but is manufactured to somewhat more stringent standards.
- CAT 6 cable is manufactured to tighter requirements than CAT 5E cable. CAT 6 has higher measured frequency ranges and significantly better performance requirements than CAT 5E cable at the same frequencies.

Wiring Standards

There are two supported wiring standards for 8-conductor (4-pair) RJ-45 terminated UTP cable: EIA/TIA 568A and B. These standards apply to

installations utilizing UTP cable specifications. The RCS system supports either of these wiring standards. The following table describes the standards for each pin.

Table E.1: UTP wiring standards

Pin	EIA/TIA 568A	EIA/TIA 568B
1	white/green	white/orange
2	green	orange
3	white/orange	white/green
4	blue	blue
5	white/blue	white/blue
6	orange	green
7	white/brown	white/brown
8	brown	brown

Cabling Installation, Maintenance, and Safety Tips

The following is a list of important safety considerations that should be reviewed prior to installing or maintaining your cables:

- Keep all UTP runs to a maximum of 30 feet each.
- Maintain the twists of the pairs all the way to the point of termination, or no more than one-half inch untwisted. Do not skin off more than one inch of the jacket while terminating.

- If bending the cable is necessary, make it gradual with no bend sharper than a one inch radius. Allowing the cable to be sharply bent or kinked can permanently damage the cable's interior.
- Dress the cables neatly with cable ties, using low to moderate pressure. Do not over tighten the ties.
- Cross-connect cables where necessary, using rated punch blocks, patch panels, and components. Do not splice or bridge the cable at any point.
- Keep the UTP cable as far away as possible from potential sources of EMI, such as electrical cables, transformers, and light fixtures. Do not tie the cables to electrical conduits or lay the cables on electrical fixtures.
- Always test every installed segment with a cable tester. Toning alone is not an acceptable test.
- Always install jacks so as to prevent dust and other contaminants from settling on the contacts. The contacts of the jack should face up on the flush mounted plates, or left/right/down on surface mount boxes.
- Always leave extra slack on the cables, neatly coiled in the ceiling or nearest concealed location. Leave at least five feet at the work outlet side and 15 feet at the patch panel side.
- Choose either 568A or 568B wiring standard before beginning. Wire all jacks and patch panels for the same wiring scheme. Do not mix 568A and 568B wiring in the same installation.
- Always obey all local and national fire and building codes. Be sure to firestop all the cables that penetrate a firewall. Use plenum-rated cable where it is required.

Appendix F: Sun Advanced Key Emulation

Certain keys on a standard Type 5 (US) Sun keyboard can be emulated by key press sequences on the local port USB keyboard. To enable Sun Advanced Key Emulation mode and use these keys, press and hold <Ctrl+Shift+Alt> and then press the <Scroll Lock> key. The Scroll Lock LED blinks. Use the indicated keys in the following table as you would use the advanced keys on a Sun keyboard. For example: For <Stop + A>, press and hold <Ctrl+Shift+Alt> and press <Scroll Lock>, then <F1 + A>.

These key combinations will work with the Dell USB, USB2, and USB2+CAC SIPs and Avocent USB, USB2, and VMC IQ modules. With the exception of <F12>, these key combinations are not recognized by Microsoft Windows. Using <F12> performs a Windows key press. When finished, press and hold <Ctrl+Shift+Alt> and then press the <Scroll Lock> key to toggle Sun Advanced Key Emulation mode off.

Table F.1: Sun Key Emulation

Compose	Application ¹
Compose	keypad
Power	F11
Open	F7

Help	Num Lock
Props	F3
Front	F5
Stop	F1
Again	F2
Undo	F4
Cut	F10
Copy	F6
Paste	F8
Find	F9
Mute	keypad /
Vol.+	keypad +
Vol.-	keypad -
Command (left) ²	F12
Command (left) ²	Win (GUI) left ¹
Command (right) ²	Win (GUI) right ¹

ENDNOTES:

(1) Windows 95 104-key keyboard.

(2) The Command key is the Sun Meta (diamond) key.

Appendix G: Technical Specifications

Table G.1: RCS Technical Specifications

	1082DS: 8
Number of ports	2162DS: 16 4322DS: 32
Type	Dell PS/2, USB, USB2, USB2+CAC, and Serial SIPs. Avocent PS/2, PS2M, USB, Sun, USB2, VMC, and Serial modules.
Connectors	8-pin modular (RJ-45)
Sync types	Separate horizontal and vertical

Input video resolution	Standard 640 x 480 @ 60 Hz 800 x 600 @ 75 Hz 960 x 700 @ 75 Hz 1024 x 768 @ 75 Hz 1280 x 1024 @ 75 Hz 1600 x 1200 @ 60 Hz Widescreen 800 x 500 @ 60 Hz 1024 x 640 @ 60 Hz 1280 x 800 @ 60 Hz 1440 x 900 @ 60 Hz 1680 x 1050 @ 60 Hz
Supported cabling	4-pair UTP, 45 meters maximum length
Dimensions	
Form factor	1U or 0U rack mount
Dimensions	1.72 x 17.00 x 9.20 (Height x Width x Depth)
Weight (without cables)	1082DS: 6.6 lb (3.0 kg) 2162DS: 7.0 lb (3.2 kg) 4322DS: 7.6 lb (3.4 kg)
SETUP port	
Number	1
Protocol	RS-232 serial
Connector	8-pin modular (RJ-45)
Local port	

Number/Type	1 VGA/4 USB
Network connection	
Number	2
Protocol	10/100/1000 Ethernet
Connector	8-pin modular (RJ-45)
USB device port	
Number	4
Protocol	USB 2.0
MODEM port	
Number	1
Protocol	RS-232 serial
Connectors	8-pin modular (RJ-45)
PDU port	
Number	2
Protocol	RS-232 serial
Connector	8-pin modular (RJ-45)
Power specifications	
	1082DS: 1 IEC C14
Connectors	2162DS: 2 IEC C14
	4322DS: 2 IEC C14
Type	Internal

Power	18W
Heat dissipation	47 BTU/hr
AC input range	100 - 240 VAC
AC frequency	50/60 Hz auto-sensing
AC input current rating	1.25 A
AC input power (maximum)	40 W
Ambient atmospheric condition ratings	
Temperature	32 to 122 degrees Fahrenheit (0 to 50 degrees Celsius) operating; -4 to 158 degrees Fahrenheit (-20 to 70 degrees Celsius) non-operating
Humidity	Operating: 20% to 80 % relative humidity (non-condensing Non-operating: 5% to 95% relative humidity, 38.7 degrees C maximum wet bulb temperature
Safety and EMC Standards approvals and markings	UL / cUL, CE - EU, N (Nemko), GOST, C-Tick, NOM / NYCE, MIC (KCC), SASO, TUV-GS, IRAM, FCC, ICES, VCCI, SoNCAP, SABS, Bellis, FIS/ Kvalitet, Koncar, INSM, Ukrtest, STZ, KUCAS Safety certifications and EMC certifications for this product are obtained under one or more of the following designations: CMN (Certification Model Number), MPN (Manufacturer's Part Number), or Sales Level Model designation. The designation that is referenced in the EMC and/or safety reports and certificates are printed on the label applied to this product.



Appendix H: Technical Support

Our Technical Support staff is ready to assist you with any installation or operating issues you encounter with your Dell product. If an issue should develop, follow the steps below for the fastest possible service.

To resolve an issue:

- 1 Check the pertinent section of this manual to see if the issue can be resolved by following the procedures outlined.
- 2 Check our web site at dell.com/support to search the knowledge base or use the on-line service request.
- 3 Call the Dell Technical Support location nearest you.

